

Performance of Solar Panels on Spandex and Asbestos Roofs

By Nur Hamzah

Performance of Solar Panels on Spandex and Asbestos Roofs

Abstract. Installation of Rooftop Solar Panels currently only considers the power capacity to be installed and the available roof area, but does not consider the type of roofing material where the solar panels are installed. The roof of the house has the absorption of sunlight and different thermal properties depending on the type of roofing material. In this study, discusses the effect of using house roofing materials on the performance of solar panels. In this study, 2 types of roofing materials were used, namely Asbestos Roof and Spandex Roof. In addition, this study discusses the effect of the height between the solar panels and the roof on the temperature and its effect on the efficiency of the solar panels. Based on this research, the temperature characteristics between the solar panels and the roof (T3) of various types of materials affect the efficiency value of the solar panels, where the maximum efficiency value is obtained for asbestos roofing material at a temperature (T3) of 35.56°C of 5.35% and spandex roofing at a temperature of (T3) 35.16°C of 4.53%.

Streszczenie. Instalacja dachowych paneli słonecznych obecnie uwzględnia tylko moc do zainstalowania i dostępną powierzchnię dachu, ale nie bierze pod uwagę rodzaju pokrycia dachowego, na którym są zainstalowane panele słoneczne. Dach domu charakteryzuje się pochłanianiem światła słonecznego i różnymi właściwościami termicznymi w zależności od rodzaju pokrycia dachowego. W niniejszym opracowaniu omówiono wpływ zastosowania pokryć dachowych domu na wydajność paneli słonecznych. W niniejszym badaniu zastosowano 2 rodzaje pokryć dachowych, a mianowicie dach azbestowy i dach spandexowy. Ponadto w niniejszym opracowaniu omówiono wpływ wysokości między panelami słonecznymi a dachem na temperaturę i jej wpływ na wydajność paneli słonecznych. Na podstawie tych badań charakterystyka temperaturowa pomiędzy panelami słonecznymi a dachem (T3) z różnych rodzajów materiałów wpływa na wartość sprawności paneli słonecznych, gdzie maksymalna wartość sprawności jest uzyskiwana dla pokrycia dachowego z azbestu w temperaturze (T3) 35,56°C 5,35% i pokrycie dachowe ze spandeksu w temperaturze (T3) 35,16°C 4,53%. (**Wydajność paneli słonecznych na dachach ze spandeksu i azbestu**)

Keywords: Solar Panel, Rooftop, Asbestos Roof, Spandex Roof, Efficiency.

Słowa kluczowe: panel słoneczny, dach, dach azbestowy, dach z elastanu, wydajność.

20

1. Introduction

Solar energy is a renewable energy that can be used as an alternative energy source. The use of solar energy can meet some of the electrical energy needs in Indonesia. Indonesia's geographical location supports the availability of solar energy throughout the year. The application of solar power plants is very suitable for remote areas that are difficult to reach by a centralized power grid [1].

One application of photovoltaic solar energy technology that is currently being developed is the technology of Solar Power Generation on the roof of the building or rooftop solar cell. Rooftop solar cell technology is a reliable solution for energy supply [2]. The advantages of solar panels are that they are easy and inexpensive to integrate with existing electrical systems, and can reduce the load on the system network. In addition, the application of this system is easy to maintain and operate, and has a significant impact in reducing pollution and the greenhouse effect [3].

The potential of solar energy today in Indonesia is very large [4]. Several studies have discussed the use of rooftop PV panel technology, among others [5] discussing the application of rooftop solar power plants in campus buildings. [6] has investigated the design of off-grid solar panel roofs in residential homes as an alternative source of electrical energy. [7] discusses strategies for the application of solar cells for residential and commercial buildings. [8] discusses the application of rooftop solar power generation to reduce electricity consumption during peak load conditions. The application of roof PV panels in buildings has been proposed by many researchers [9-11]. The review papers about solar tracking system [12], solar PV cleaning technology [13], Solar photovoltaic system cooling technology [14] have been documented. The application of control and optimization technology to solar cells has also been developed by many researchers such as PSO-PR Power flow Control [15], grid-connected SmartInverter control [16] and Grid-Connected PV Inverter control using Discrete-Time Integral Variable Structure [17].

Installation of roof solar panels currently only considers the power capacity to be installed [18], and the

available roof area. However, it does not consider the type of roofing material where the PV is installed. While the roof of the house has the characteristics of absorption of sunlight and different thermal properties depending on the type of roofing material. Several previous studies have been conducted to determine the effect of temperature on the roof covering including [19], [20], and [21], which have investigated the thermal conditions of the roof space produced from various types of roofing materials such as tile, asbestos and zinc. The results of this study indicate that the average temperature of the roof space on roof tiles is 1.91°C to 2.31°C, lower than that of asbestos and tile roofs. Tile roofs can withstand solar radiation better. The average surface temperature of the tile roof was 0.28 °C lower than the surface temperature of the asbestos roof and 1.55°C lower than the surface temperature of the zinc roof. However, the lowest average roof surface temperature profile during the day on an asbestos roof is 38.71°C. [20] have discussed the manufacture and testing of tools for determining the conductivity of zinc, multiroof, and asbestos plates. The results showed that the highest conductivity value was found in the zinc plate (0.482 W/m°C), and the lowest conductivity value found in the multi-roof (0.132 W/m°C). [21] discussed the effect of Solar Photovoltaic Panels on Roof Heat Transfer [21] where the roof temperature under PV is 2.5 times more relaxing than the roof exposed to the sun.

In [22] discusses the thermal characteristics of the installation of roof PV panels. Several other previous studies discussed the effect of the type of roofing material used as a place to install roof PV panels on the temperature between the solar panels and the roof, and have not studied the effect of the distance between the solar panels and the type of roof. When the material about the temperature of the solar panel and its impact on the efficiency of the solar panel has not been discussed. This experiment is conducted to obtain the characteristics of the I-V curve and the efficiency of solar panels mounted on roofs made of asbestos and spandex roofing materials. In this study, the height of the solar panels on the roof was varied at 20, 25, 30 and 35 cm.

2. Methods

2.1. Research Instrument Design

For the solar panel mount frame, hollow iron material measuring 4 x 4 cm is used and also angled iron measuring 3 x 3 cm. Acrylic material is used for the material on the load panel. Figure 1 below shows the design of the solar panel frame and roof [23].

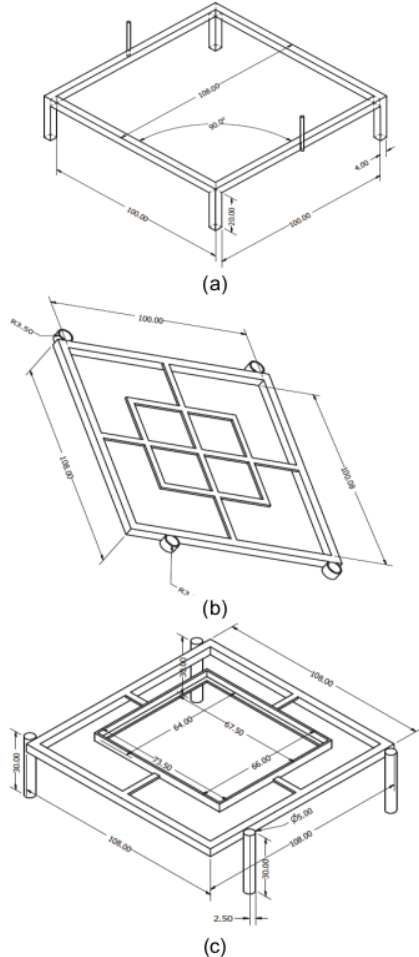

Fig 1. (a). Solar Panel Mount Design, (b). Tile Mount Design, (c) Dimensions of Solar Panel and Roof Frame

In designing the load panel as the output of the solar panel, the acrylic material is used with a size of 75 x 60 cm. The following figure 2 shows the research instrument placement design.

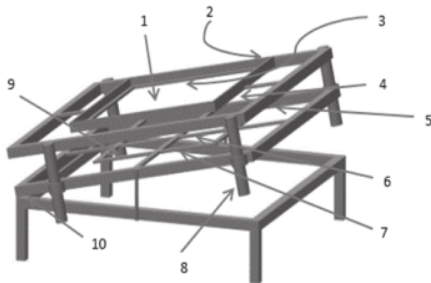

Fig 2. Research Instrument Placement Design

Information:

1. Solar Panel Mount
2. Place Solar Simulator
3. Temperature over solar panel, T_1 ($^{\circ}\text{C}$)
4. Temperature under solar panel, T_2 ($^{\circ}\text{C}$)
5. Temperature between solar panel and roof, T_3 ($^{\circ}\text{C}$)
6. Temperature on the roof, T_4 ($^{\circ}\text{C}$)
7. Temperature under the roof, T_5 ($^{\circ}\text{C}$)
8. Distance Variation Controller (cm)
9. Roof Mount
10. Tilt Angle ($^{\circ}$)

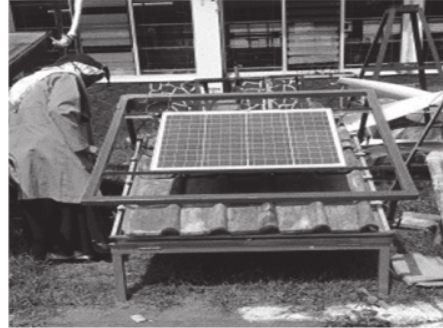

Fig 3. Data Retrieval Process

2.1. Testing Procedure

After the process of manufacturing and installing the research components is complete, it is followed by the testing procedure. The steps in the testing procedure are as follows:

1. The test will be carried out at 09.00 until 15.00 local time.
2. Adjust the angle of the solar panels based on the type of roof used.
3. Installing solar panels on the roof material with a distance of H1.
4. Measure the distance (cm) between solar panels and the roof being used.
5. Take temperature measurements on top of the solar panel ($^{\circ}\text{C}$) and the temperature between the solar panel and the roof ($^{\circ}\text{C}$) using the TC-O8 Thermocouple Data Logger.
6. Measuring the amount of solar radiation (W / m^2) on a solar panel using a Solar Power Meter SPM-1116SD measuring instrument.
7. Connect the solar panel output to the load panel and turn the toggle switch ON.
8. Connect a Datalogger Voltmeter and Ammeter with a laptop to observe the amount of current and voltage on the solar panel.

➤ To ensure that the datalogger and measurement instruments on the load panel are functioning correctly, it can be determined by turning ON the switch on the lamp, then increasing the voltage by turning the potentiometer, in this case, the dimmer to its top condition. The brightness of the lamp will be directly proportional to the amount of current and voltage and the intensity of the sun received by the solar panel. After all, measuring instruments are functioning correctly, then data retrieval can be carried out.

9. Procedure 1 to 9 is repeated with H2 and H3 intervals.
10. Procedures 1 to 10 are repeated for asbestos roof and spandex roof.

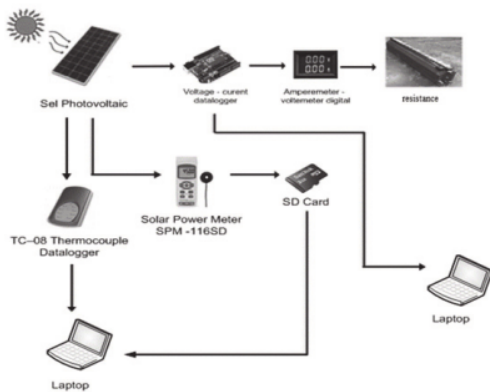

Fig 4. Schematic of PLTS Rooftop

3. Results and Discussion

The research data contains solar panel parameters measured on different types of roofing materials, namely Asbestos Roof and Spandex Roof. For every kind of roof, the measurement data is also detailed in the various sizes of solar panels and roof distances, covering a distance of 35 cm, 30 cm, 25 cm, and 20 cm. In the variation of length, the research was conducted at 3 (three) observation times, namely at 09.30 WITA, 12.30 WITA, and 14.30 WITA.

The measurement data needed in this study include:

- Solar radiation, G_{bt} (W/m^2)
- Temperature over solar panels, T_1 ($^{\circ}C$)
- Temperature under solar panel, T_2 ($^{\circ}C$)
- Temperature between solar panel and roof, T_3 ($^{\circ}C$)
- Temperature on the roof, T_4 ($^{\circ}C$)
- Temperature under the roof, T_5 ($^{\circ}C$)
- Solar panel current, I (A).
- Solar panel voltage, V (V)
- Time, (WITA)

The following is research data from each of the above categories, which is taken from the average value of the measurement results.

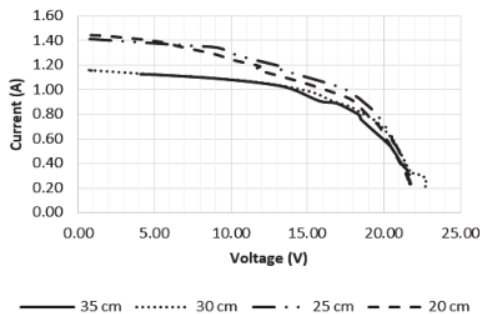

Fig 5. Characteristics of I-V Curves with Various Variations of Solar Panel Spacing on Asbestos Roof for the First Experiment

3.1. Characteristics of I-V on Asbestos Roof

Figure 5 shows the characteristics of the I-V curve with various variations in the distance of the solar panels on Asbestos Roof for the first experiment. In this graph, it can be seen that the voltage generated by the solar panel is inversely proportional to the amount of current flowing, where the more significant the voltage, the smaller the current. This is influenced by the resistive load (shear resistance) used in this experiment which is varied from the maximum value to the minimum value for each variation of the distance between the solar panels and Asbestos Roof.

It appears that the largest voltage value is obtained at a distance of 30 cm, which is 22.75 V with a current value of 0.27 A.

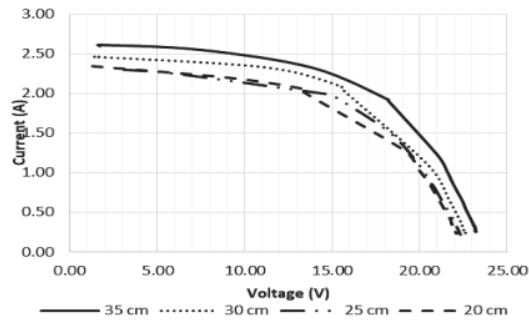

Fig 6. Characteristics of I-V Curves with Various Variations of Solar Panel Spacing on Asbestos Roof for the Second Experiment

Figure 6 shows the characteristics of the I-V curve with variations in the distance of the solar panels on the asbestos tile for the second experiment. From this second experiment, the current and voltage characteristics are almost the same as the first experiment, namely the voltage generated by the solar panel is inversely proportional to the amount of current flowing, where the greater the voltage, the smaller the current. The effect is the same as in the first experiment, which is influenced by the resistive load used in this experiment, where the load is varied from the maximum value to the minimum value for each variation of the distance between the solar panels and the asbestos roof. In this second experiment, the voltage values for each variation with a distance of 35 cm, 30 cm, 25 cm, and 20 cm tend to be constant following changes in the value of the shear resistance. Compared to other distances, the minimum current and voltage characteristics are shown at a distance of 20 cm, this is due to the effect of convection heat transfer between solar panels and asbestos roof at a distance of 20 cm is greater because this experiment is carried out when solar radiation is at its maximum value (daylight). The largest value in this second experiment was obtained at a distance of 35 cm with a value of 23.24 V with a current of 0.26 A.

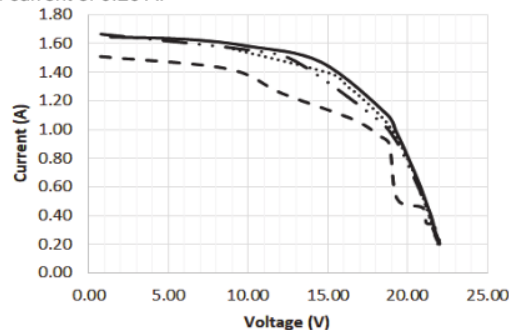

Fig 7. Characteristics of I-V Curves with Variations of Solar Panel Spacing on Asbestos Roof for the Third Experiment

While in Figure 7 is a characteristic I-V curve with various variations in the distance of the solar panels on the asbestos tile for the third experiment. The third experiment shows the same trend as the previous experiment, where

5 the voltage generated by the solar panel is inversely 10 proportional to the amount of current flowing, where the greater the voltage, the smaller the current. This is because the effect of the resistive load used in this experiment is varied from the 3 maximum value to the minimum value for each variation of the distance between the solar panels and the asbestos roof. The graph above shows that the voltage values for each variation with a distance of 35 cm, 30 cm, and 22 cm tend to be constant following changes in the value of the shear resistance. However, at a distance of 20 cm the graph trend appears to be fluctuating where the change in the current value is quite large at a voltage of 18.26 V. The largest value is obtained at a distance of 35 cm with a value of 22.01 V with a current of 0.21 A.

3.2. Characteristics of I-V on Spandex Roof

To compare the performance of the previous experiment with asbestos roofs, the second experiment used spandex roofs. Figure 8 shows the characteristics of the I-V curve with various variations in the distance of the solar panels on the spandek roof for the first experiment. The same thing is also obtained in this test, where the maximum to minimum load variation of the resistive load causes the voltage generated by the solar panel to be inversely proportional to the amount of current flowing, where the greater the voltage, the smaller the current for each variation of the distance between the solar panels and asbestos roofs. The graph above shows that 6 the voltage values for each variation with a distance of 35 cm, 30 cm, 25 cm, and 20 cm tend to be constant following changes in the value of the shear resistance. The largest value is obtained at a distance of 30 cm with a value of 23.61 V with a current of 0.23 A.

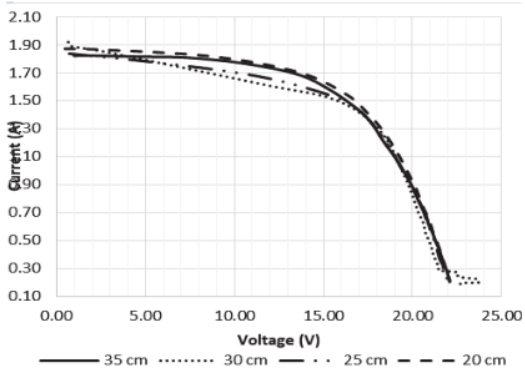

Fig 8. Characteristics of I-V Curves with Various Spacing of Solar Panels on Spandex Roof for the First Experiment

The next test in the second experiment with a spandex roof is shown in Figure 9, the characteristics of the I-V curve with various variations in the distance of the solar panels on the spandek roof. From this second test, it shows 5 the same trend as the previous experiment, where the voltage generated by the solar panel is inversely proportional to the amount of current flowing, where the greater the voltage, the smaller the current. This is also influenced by the resistive load used where the load is varied from the 3 maximum value to the minimum value for each variation of the distance between the solar panels and the asbestos roof. In this second experiment, 6 the voltage value for each variation with a distance of 35 cm, 30 cm, 25 cm, and 20 cm obtained is almost the same as the previous test, which tends to be constant following changes in the value of the shear resistance. The largest value is obtained at a

distance of 35 cm with a value of 23.05 V with a current of 0.30 A.

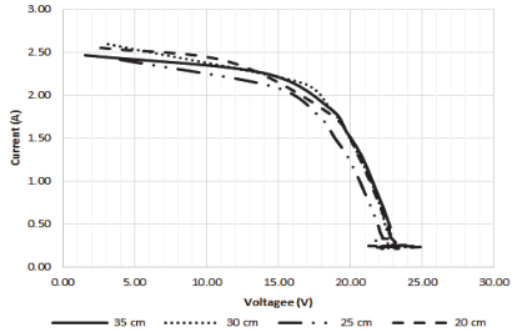

Fig 9. Characteristics of I-V Curves with Various Spacing of Solar Panels on Spandex Roof for the Second Experiment

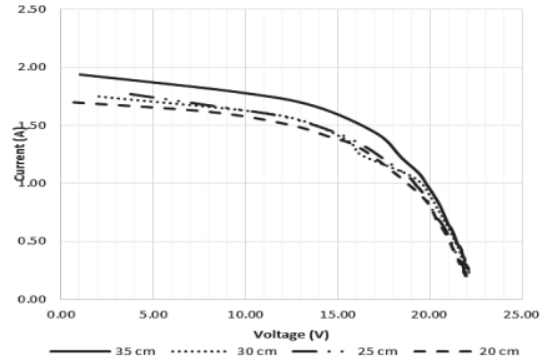

Fig 10. Characteristics of I-V Curves with Various Spacing of Solar Panels on Spandex Roof for the Third Experiment

The third test with a spandex roof, 13 the results are shown in Figure 10 for the characteristics of the I-V curve with various variations in the distance of the solar panels on the spandek roof. In this third test, the characteristics 5 are almost the same as the previous experiment, where the voltage generated by the solar panel is inversely proportional to the amount of current flowing, where the greater the voltage, the smaller the current. This is influenced by the resistive load used in this experiment which varies from the 3 maximum value to the minimum value for each variation of the distance between the solar panels and the asbestos roof. The graph above shows that 6 the voltage values for each variation with a distance of 35 cm, 30 cm, 25 cm, and 20 cm tend to be constant following changes in the value of the shear resistance. The largest value is obtained at a distance of 30 cm with a value of 22.17 V with a current of 0.21 A.

Based on the two types of experiments with asbestos and spandex roofing shown in Figure 5-10, the characteristics of battery charging are controlled using the Battery Control Regulator (BCR). BCR is a battery charging controller circuit in a solar cell system by adjusting the voltage used to charge the battery in a voltage range of 11.4 V to 14.5 V as shown in the graph above for charging a 12 V battery. If the battery voltage drops to 11.4 V, the controller will charge the battery if the sun is shining at that time, but if it is at night, the controller will cut off the supply of electrical energy. If the battery voltage rises to 14.5 V, the controller will stop charging. Excessive battery voltage will result in a relatively short battery life.

III.3. Solar Panel Temperature Characteristics

Figure 11 shows a comparison of temperature characteristics for several variations of the distance on the type of Asbestos Roof material. Tests using asbestos roofing materials showed that at a distance of 35 cm the highest T3 temperature in tests using asbestos roofing materials was obtained in tests conducted at 09.30 WITA, which was around 33.33°C. Furthermore, in the test with a distance of 30 cm, the highest T3 temperature was found in the test carried out at 14.30 WITA which was around 32.81°C. Furthermore, in the test with a distance of 25 cm, the highest T3 temperature was found in the test conducted at 14.30 WITA which was around 32.42°C. Furthermore, in the test with a distance of 20 cm, the highest T3 temperature was found in the test carried out at 09.30 WITA which was around 33.24°C. Table 1 shows the results of testing the characteristics of solar panels on Asbestos Roofs.

The next temperature characteristic test is for the Spandex Roof material, with several variations of distance. In testing using the type of spandex roof material, it shows that at a distance of 35 cm the highest T3 temperature in the test using the Spandex Roof material was obtained in the test conducted at 12.30 WITA which is around 35.80°C. Furthermore, in the test with a distance of 30 cm, the highest T3 temperature was found in the test carried out at 14.30 WITA which was around 36.82°C. Furthermore, in the test with a distance of 25 cm, the highest T3 temperature was found in the test carried out at 14.30 WITA around 37.67°C. Furthermore, in the test with a distance of 20 cm, the highest T3 temperature was found in the test carried out at 14.30 WITA which was around 35.62°C. Table 2 shows the results of testing the characteristics of the solar panels on the Spandex Roof.

TABLE I. COMPARISON OF TEMPERATURE CHARACTERISTICS OF ASBESTOS ROOF

Distance (cm)	Time (WITA)	G_{bt} (W/m ²)	T_1 (°C)	T_2 (°C)	T_3 (°C)	T_4 (°C)	T_5 (°C)
35	09.30	484.4	35.09	30.81	33.33	35.56	33.02
	12.30	1088	32.37	26.96	30.34	31.51	29.34
	14.30	688.7	33.61	34.55	32.56	34.50	32.18
30	09.30	599.3	34.57	29.85	32.72	35.66	32.46
	12.30	1056	33.92	21.94	26.71	33.31	31.75
	14.30	676.8	36.93	34.64	32.81	34.34	33.62
25	09.30	556.4	35.88	29.89	32.34	35.42	31.98
	12.30	1035	35.24	29.81	26.65	34.59	32.40
	14.30	681.5	36.32	33.16	32.42	34.90	34.49
20	09.30	512.8	40.62	30.13	33.24	35.61	34.07
	12.30	1048	35.97	28.24	27.03	34.54	33.07
	14.30	691.5	36.52	34.14	32.78	34.71	33.64

TABLE II. COMPARISON OF TEMPERATURE CHARACTERISTICS OF SPANDEX ROOF

Height (cm)	Time (WITA)	G_{bt} (W/m ²)	I (A)	T_1 (°C)	T_2 (°C)	T_3 (°C)	T_4 (°C)	T_5 (°C)
35	09.30	783.3	0.92	56.01	47.86	30.18	35.16	33.85
	12.30	957.9	0.66	50.62	49.41	35.80	37.51	34.82
	14.30	776	0.65	57.42	54.35	34.14	38.29	37.07
30	09.30	797.9	0.63	57.30	51.04	31.51	35.67	34.55
	12.30	1069	0.66	49.98	48.66	35.00	37.74	35.25
	14.30	755.3	0.53	58.51	57.06	36.82	40.02	38.55
25	09.30	826.2	0.66	51.95	48.44	32.37	36.08	33.34
	12.30	1039	0.69	56.36	55.65	35.51	39.20	36.45
	14.30	726.7	0.67	60.13	58.40	37.67	42.11	40.70
20	09.30	847.3	0.73	58.96	54.12	34.39	37.48	35.56
	12.30	1064	0.49	53.79	51.47	35.59	38.71	37.67
	14.30	724.2	0.53	58.96	56.72	35.62	41.32	39.09

Testing the temperature characteristics of solar panels on the Asbestos Roof shows a graph of a temperature trend that fluctuates from 09.30 to 14.30. Meanwhile, in the Spandex Roof material test, the temperature chart trend increased from 09.30 to 14.30. From the results of testing with asbestos roofs, the temperature values fluctuate, this is because this roof is a poor conductor so that heat from the roofing material will be difficult to transfer to the top of the solar panel.

For example, at 12.30 WITA, the highest T3 temperature was produced using spandex roofing material. This is because spandex roofs are good conductors so that during the day, conduction heat transfer will be greater so that the temperature between the solar panels and the roof is also large. Based on graph 10, it can be seen that spandex roof is the material that has the highest temperature of 35.80 C in the test conducted at 12.30 WITA.

3.4. Solar Panel Efficiency Comparison

For efficiency analysis, calculations are carried out by taking the sample data in Table 1 (on asbestos roof with a

distance of 35 cm at 09.30 WITA). The parameters are as follows:

- The intensity of solar radiation, $G_{bt} = 783,3 \text{ W/m}^2$
- Voltage, $V = 17,11 \text{ V}$
- Current, $I = 0,92 \text{ A}$
- Cross-sectional area, $A = 0,538 \times 0,636 = 0,342 \text{ m}^2$
- Temperature on top of the solar panels, $T_1 = 56,01 \text{ }^\circ\text{C}$
- Temperature under solar panels, $T_2 = 47,86 \text{ }^\circ\text{C}$
- Temperature between solar panels and roof, $T_3 = 30,18 \text{ }^\circ\text{C}$
- Temperature on the roof, $T_4 = 35,16 \text{ }^\circ\text{C}$
- Temperature under the roof, $T_5 = 33,85 \text{ }^\circ\text{C}$
- Time = 9.30 WITA

The following is the complete calculation of input power, output power, and solar panel efficiency shown in table 3 for asbestos roof tile material types and table 4 for ceramic tile materials.

TABLE 3. POWER AND EFFICIENCY OF SOLAR PANEL ON ASBESTOS ROOF

Height (cm)	Time (WITA)	G_{bt} (W/m^2)	V (V)	I (A)	P_{out} (W)	P_{in} (W)	η (%)
35	09.30	484.4	18.66	0.54	8.79	165.74	5.35
	12.30	1088	20.32	0.81	12.18	372.17	3.26
	14.30	688.7	19.70	0.52	8.13	235.66	3.44
30	09.30	599.3	18.49	0.55	8.30	205.06	4.52
	12.30	1056	18.78	0.81	9.40	361.16	2.60
	14.30	676.8	20.03	0.55	9.59	231.56	4.14
25	09.30	556.4	18.47	0.64	10.06	190.39	5.27
	12.30	1035	19.50	0.74	10.92	354.28	3.08
	14.30	681.5	20.03	0.49	8.04	233.17	3.45
20	09.30	512.8	17.01	0.68	8.79	175.45	4.94
	12.30	1048	20.06	0.64	10.02	358.57	2.80
	14.30	691.5	19.79	0.51	8.34	236.62	3.53

TABLE 3. POWER AND EFFICIENCY OF SOLAR PANEL ON SPANDEX ROOF

Height (cm)	Time (WITA)	G_{bt} (W/m^2)	V (V)	I (A)	P_{out} (W)	P_{in} (W)	η (%)
35	09.30	783.3	17.11	0.92	12.13	317.22	3.83
	12.30	957.9	21.27	0.66	12.03	387.96	2.98
	14.30	776	19.92	0.65	11.04	314.29	3.51
30	09.30	797.9	19.15	0.63	8.80	323.17	2.72
	12.30	1069	21.46	0.66	12.22	432.82	2.79
	14.30	755.3	20.28	0.53	9.18	305.91	3.00
25	09.30	826.2	19.13	0.66	10.15	334.60	3.04
	12.30	1039	20.95	0.69	12.53	420.94	2.96
	14.30	726.7	19.35	0.67	10.99	294.31	3.74
20	09.30	847.3	18.98	0.73	11.26	343.17	3.28
	12.30	1064	22.25	0.49	9.29	431.04	2.26
	14.30	724.2	19.66	0.53	8.48	293.29	2.89

Based on Figure 12, it shows a comparison of efficiency for a height of 35 cm on the types of asbestos and spandex roofing materials. In the graph for testing the asbestos roofing material, it can be seen that the efficiency of the solar panel (η) in the test carried out at 09.30 WITA looks greater than the test carried out at 12.30 WITA, then tends to be constant and does not experience too significant changes in the test carried out at 12.30 WITA. at 14.30 WITA. The highest efficiency value was obtained from asbestos roofing material with a test time of 09.30 WITA of 5.35%. Meanwhile, the lowest efficiency value was obtained from the spandex roof testing with the testing time at 12.30 WITA, namely 2.98%. While at a height of 30 cm, the highest efficiency value in the asbestos roof testing at 09.30 WITA was 4.52%. Meanwhile, the lowest efficiency value was obtained from the asbestos roof testing with the testing time at 12.30 WITA which is 2.60%. Meanwhile, at a height of 25 cm, the highest efficiency value obtained by asbestos roofing material was 5.27% at the time of testing at 09.30 WITA. Meanwhile, the lowest efficiency value was obtained from the spandex roof test with the testing time at 12.30 WITA, namely 2.96%. While at a height of 20 cm, the highest efficiency value obtained on the type of asbestos roofing material is 4.94% at the time of testing at 09.30 WITA. While the lowest efficiency value was obtained in the spandex roof test with the testing time at 12.30 WITA which is 2.26%.

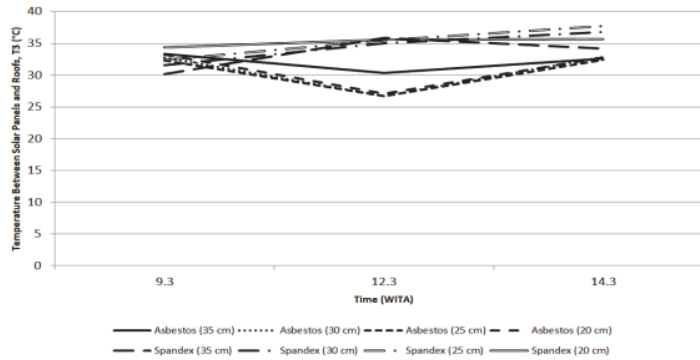

Fig 11. Comparison of temperature characteristics for Asbestos Roof and Spandex Roof

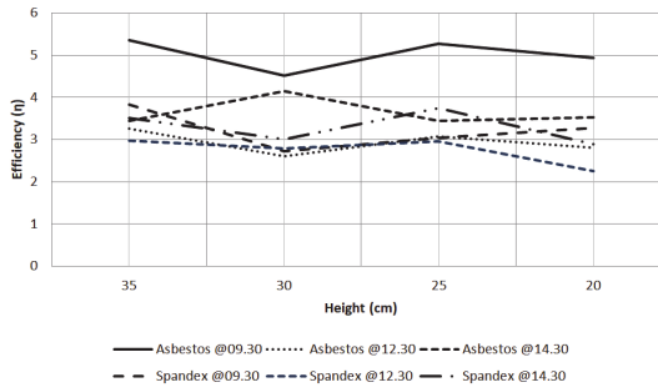

Fig 12. Comparison of the Efficiency of Solar Panels

The efficiency value in this experiment is influenced by the measured value of solar radiation and temperature based on variations in height between the roof and solar panels. Other factors that affect the efficiency of solar panels in this study such as wind speed and reflectance of sunlight from roofing materials to solar panels are assumed not to have much effect on this experiment because the test framework (solar panels and roofs) are not placed on tall buildings so that the factor -these factors are ignored. The weather conditions are based on BMKG sources in the data collection process for asbestos roofs in the morning the conditions are cloudy, sunny in the afternoon, and the temperature is between 23 - 32°C and humidity is 60-85%. Meanwhile, the weather conditions in the data collection process for spandek roofs were cloudy in the morning, cloudy in the afternoon, and the temperature was between 27 - 31°C.

8

4. Conclusion

Based on the research that has been done, it can be concluded that:

1. Based on this research, the temperature characteristics between the solar panel and the roof (T3) of various types of material have an influence on the efficiency value of the solar panel, where the maximum efficiency value of the solar panel is obtained for the type of material:

a. Asbestos roof at a temperature (T3) of 35.56°C, with a maximum efficiency value of 5.35% with sunny cloudy weather conditions.

b. Spandek roof at a temperature (T3) of 35.16°C, with a maximum efficiency value of 4.53% with sunny cloudy weather conditions.

2. Based on the results of data observations in this study, the optimal distance between the solar panels and the roof was obtained, for the maximum efficiency value, namely: asbestos roof with a distance of 35 cm, and spandek roof with a distance of 35 cm.

Authors' information

^{1,2,3}Department of Mechanical Engineering, Energy Power Plant Engineering, State Polytechnic of Ujung Pandang.

Email : ¹hamzah_said@poliupg.ac.id

²firman@poliupg.ac.id,

³wandi@poliupg.ac.id

REFERENCES

- [1] D. Septiadi, P. Nanlohy, M. Souissa, and F. Y. Rumlawang, "Proyeksi potensi energi surya sebagai energi terbarukan (Studi wilayah Ambon dan sekitarnya)," *Jurnal Meteorologi dan Geofisika*, vol. 10, no. 1, 2009.
- [2] J. Peng and L. Lu, "Investigation on the development potential of rooftop PV system in Hong Kong and its environmental benefits," *Renewable and Sustainable Energy Reviews*, vol. 27, pp. 149-162, 2013.
- [3] S. Castellanos, D. A. Sunter, and D. M. Kammen, "Rooftop solar photovoltaic potential in cities: how scalable are assessment approaches?," *Environmental Research Letters*, vol. 12, no. 12, p. 125005, 2017.
- [4] N. Handayani, "Potency of solar energy applications in Indonesia," *International Journal of Renewable Energy Development*, vol. 1, no. 2, pp. 33-38, 2012.
- [5] E. Tarigan, "Simulation and feasibility studies of rooftop PV system for university campus buildings in Surabaya, Indonesia," *International Journal of Renewable Energy Research*, vol. 8, no. 2, pp. 895-908, 2018.
- [6] M. F. Hakim, "Perancangan Rooftop Off Grid Solar Panel pada rumah tinggal sebagai alternatif sumber energi listrik," *Dinamika DotCom*, 2017.
- [7] D. S. Mintorogo, "Strategi aplikasi sel surya (photovoltaic cells) pada Perumahan dan bangunan komersial," *DIMENSI (Journal of Architecture and Built Environment)*, vol. 28, no. 2, 2000.
- [8] S. Syafii, N. Novizon, W. Wati, and D. Juliandri, "Feasibility Study of Rooftop Grid Connected PV System for Peak Load Reduction," *Proceeding of the Electrical Engineering Computer Science and Informatics*, vol. 5, no. 5, pp. 231-235, 2018.
- [9] Y. Kotak, E. Gago, P. Mohanty, and T. Muneer, "Installation of roof-top solar PV modules and their impact on building cooling load," *Building Services Engineering Research & Technology*, vol. 35, no. 6, 2014.
- [10] H. Altan, Z. Alshikh, V. Belpoliti, Y. K. Kim, Z. Said, and M. Alchaderchi, "An experimental study of the impact of cool roof on solar PV electricity generations on building rooftops in Sharjah, UAE," *International Journal of Low-Carbon Technologies*, vol. 14, no. 2, pp. 267-276, 2019.
- [11] F. Salamanca, M. Georgescu, A. Mahalov, M. Moustauoui, and A. Martilli, "Citywide impacts of cool roof and rooftop solar photovoltaic deployment on near-surface air temperature and cooling energy demand," *Boundary-Layer Meteorology*, vol. 161, no. 1, pp. 203-221, 2016.
- [12] S. V. J. Prakash and P. K. Dhal, "A Review: Solar Tracking System with Grid Used in Kurnool Ultra Mega Solar Park," 2019, Solar PV system; Solar Radiation; Grid-Tied Solar System; Two Axis Tracking System; Vertical Axis Tracking System; Horizontal Axis Tracking System; Estimated Losses vol. 14, no. 3, 2019.
- [13] P. A. Patil, J. Bagi, and M. Wagh, *A review on cleaning mechanism of solar photovoltaic panel*. 2017, pp. 250-256.
- [14] J. Siecker, K. Kusakana, and B. P. Numbi, "A review of solar photovoltaic systems cooling technologies," *Renewable and Sustainable Energy Reviews*, vol. 79, pp. 192-203, 11/01 2017.
- [15] D. Adolfo, D. P. Andrea, D. N. L. Pio, and M. Santolo, "PSO-PR power flow control of a single-stage grid-connected PV inverter," in *2017 IEEE 6th International Conference on Renewable Energy Research and Applications (ICRERA)*, 2017, pp. 788-792.
- [16] A. D. Pizzo, L. P. D. Noia, and S. Meo, "Super twisting sliding mode control of smart-inverters grid-connected for PV applications," in *2017 IEEE 6th International Conference on Renewable Energy Research and Applications (ICRERA)*, 2017, pp. 793-796.
- [17] S. Meo and V. Sorrentino, "Discrete-time integral variable structure control of grid-connected PV inverter," *Journal of Electrical Systems*, vol. 11, pp. 102-116, 01/01 2015.
- [18] A. S. Alghamdi, "Potential for Rooftop-Mounted PV Power Generation to Meet Domestic Electrical Demand in Saudi Arabia: Case Study of a Villa in Jeddah," *Energies*, vol. 12, no. 23, p. 4411, 2019.
- [19] A. Rahmat, E. Prianto, and S. B. Sasongko, "Studi Pengaruh Bahan Penutup Atap terhadap Kondisi Termal pada Ruang Atap," *Jurnal Arsitektur ARCADE*, vol. 1, no. 1, pp. 35-40, 2017.
- [20] E. Selparia, M. Ginting, and R. Syech, "Pembuatan dan pengujian alat untuk menentukan konduktivitas plat seng, multiroof dan asbes," Riau University.
- [21] A. Dominguez, J. Kleissl, and J. C. Luvall, "Effects of solar photovoltaic panels on roof heat transfer," *Solar Energy*, vol. 85, no. 9, pp. 2244-2255, 2011.
- [22] S. Odeh, "Thermal performance of dwellings with rooftop PV panels and PV/thermal collectors," *Energies*, vol. 11, no. 7, p. 1879, 2018.
- [23] F. Firman, N. H. Said, and M. R. Djalal, "Characteristic Analysis of Solar Panels on Clay and Ceramic Roof Tiles," 2022, Rooftop PV Panel; Clay Tiles; Ceramic Tiles; Efficiency vol. 16, no. 3, 2022.

Performance of Solar Panels on Spandex and Asbestos Roofs

ORIGINALITY REPORT

14%

SIMILARITY INDEX

PRIMARY SOURCES

1	sigma-not.pl Internet	297 words — 6%
2	pe.org.pl Internet	58 words — 1%
3	cdn.shopify.com Internet	52 words — 1%
4	jurnal.universitaskebangsaan.ac.id Internet	52 words — 1%
5	ojs2.pnb.ac.id Internet	40 words — 1%
6	www.guloggratis.dk Internet	40 words — 1%
7	www.praiseworthyprize.org Internet	35 words — 1%
8	Cedric Taruna, Levin Halim, Bagus Made Arthaya. "Initial Concept for Increasing Polycrystalline Fixed Solar Panel Efficiency with Water Treatments", 2019 International Conference on Mechatronics, Robotics and Systems Engineering (MoRSE), 2019 Crossref	18 words — < 1%

-
- 9 repo.unand.ac.id
Internet 16 words — < 1%
-
- 10 www.ijircst.org
Internet 16 words — < 1%
-
- 11 Syafii, Novizon, Wati, Dona Juliandri. "Feasibility Study of Rooftop Grid Connected PV System for Peak Load Reduction", 2018 5th International Conference on Electrical Engineering, Computer Science and Informatics (EECSI), 2018
Crossref 14 words — < 1%
-
- 12 Abdullah Shafer, Saad Alqahtani, Ali Garada, Liana Cipcigan. "Technical potential for rooftop solar photovoltaic in Commercial and Residential Areas in Saudi Arabia", 2022 57th International Universities Power Engineering Conference (UPEC), 2022
Crossref 10 words — < 1%
-
- 13 Sunaryo, Dendi Nurachman. "Propulsion System Analysis For Solar-Powered Electric Water Recreational", E3S Web of Conferences, 2018
Crossref 10 words — < 1%
-
- 14 Adeel Waqas, Jie Ji, Lijie Xu, Majid Ali, Zeashan, Jahanzeb Alvi. "Thermal and electrical management of photovoltaic panels using phase change materials – A review", Renewable and Sustainable Energy Reviews, 2018
Crossref 9 words — < 1%
-
- 15 dspace.mit.edu
Internet 9 words — < 1%
-
- 16 eprints.kfupm.edu.sa
Internet 9 words — < 1%

-
- 17 media.neliti.com
Internet 9 words — < 1%
-
- 18 Radwan A. Almasri, Mohamed A. Al-Anazi, A.F. Almarshoud, Mohammed S. Alshitawi, Nidal H. Abu-Hamdeh. "Investigating energy efficiency and solar energy in Saudi mosques to achieve zero energy or zero bill", Alexandria Engineering Journal, 2023
Crossref 8 words — < 1%
-
- 19 iea-pvps.org
Internet 8 words — < 1%
-
- 20 www.thinkswap.com
Internet 8 words — < 1%
-
- 21 Syafii Syafii, Wati Wati, Rahmad Fahreza. "Techno-economic-enviro optimization analysis of diesel/PV/wind with pumped hydro storage for Mentawai Island microgrid", Bulletin of Electrical Engineering and Informatics, 2021
Crossref 7 words — < 1%
-
- 22 eprints.undip.ac.id
Internet 7 words — < 1%

EXCLUDE QUOTES OFF

EXCLUDE BIBLIOGRAPHY ON

EXCLUDE SOURCES OFF

EXCLUDE MATCHES OFF