

Design Modification of Water Wheel Turbine With Various Configuration Variations

By Firman Firman

Design Modification of Water Wheel Turbine With Various Configuration Variations

Abstract. One of the obstacles in the open loop cooling system is that the seawater that will be discharged back to the source does not meet the requirements for the quality standards for generation wastewater. So that the waste water pit requires a long channel construction. The construction of a long waste water pit channel is needed so that convectional heat transfer occurs in the channel to achieve the temperature requirements of the generated waste water, which is around 30°C. In this study, 4 fin configuration variations were used, namely: Λ -shaped four-angled fins, V-shaped four-angled fins, two parallel transverse four-angled fins (\equiv), and two parallel four-pointed fins longitudinally (\parallel). With open channel dimensions of 7 m \times 0.1 m \times 1.3 m and the dimensions of the water wheel turbine model, namely diameter: 0.4 m, blade size: 0.8 \times 0.8 m and a total of 16 blades. Based on the research results it is known that the type of fin that has the ability to reduce temperature quickly is the type of two fins with four parallel transverse angles with a temperature drop of 5.56°C with a tilt position of 0°, while the temperature drop with a tilt position of 30° is 4.54°C. However, this type of fin generates little power because the water that hits the turbine blades will be accommodated on the inside of the turbine fin even by utilizing a large discharge. The type of fin that produces the highest efficiency (%) and output power (Watts) is the type of two parallel four-angled longitudinal fins (\parallel) with the highest efficiency value of 61.71% on a slope of 0°C and 84.95% on a slope of 30°C in order to obtain the greatest output power of 0.48 Watt at a slope of 0°C and 0.56 Watt at a slope of 30°C.

Streszczenie. Jedną z przeszkód w systemie chłodzenia z obiegiem otwartym jest to, że woda morska, która będzie odprowadzana z powrotem do źródła, nie spełnia wymagań norm jakościowych dla wytwarzania ścieków. Aby studzienka ściekowa wymagała budowy długiego kanału. Konieczna jest budowa długiego kanału ściekowego, aby w kanale następowała konwekcyjna wymiana ciepła w celu osiągnięcia wymaganej temperatury wytwarzanych ścieków, która wynosi około 30°C. W tym badaniu zastosowano 4 warianty konfiguracji płetw, a mianowicie: czterokątne płetwy w kształcie Λ , czterokątne płetwy w kształcie litery V, dwie równoległe poprzeczne czterokątne płetwy (\equiv) i dwie równoległe czteroramienne płetwy wzdłużnie (\parallel). O wymiarach otwartego kanału 7 m \times 0,1 m \times 1,3 m oraz wymiarach modelu turbiny koła wodnego, a mianowicie: średnicy: 0,4 m, wielkości łopatek: 0,8 \times 0,8 m i łącznie 16 łopatek. Na podstawie wyników badań wiadomo, że typem płetwy, który ma zdolność szybkiego obniżania temperatury jest typ dwóch płetw z czterema równoległymi kątami poprzecznymi o spadku temperatury 5,56°C przy pozycji pochylenia 0°, natomiast spadek temperatury przy pozycji pochylenia 30° wynosi 4,54°C. Jednak ten typ płetwy generuje niewielką moc, ponieważ woda, która uderza w łopatkę turbiny, będzie zatrzymywana po wewnętrznej stronie płetwy turbiny, nawet przy dużym wypływie. Typ płetwy, który zapewni najwyższą wydajność (%) i moc wyjściową (W) to typ dwóch równoległych, czterokątnych podłużnych płetw (\parallel) o najwyższej wartości sprawności 61,71% na zbroczu 0°C i 84,95% na zbroczu nachylenie 30°C w celu uzyskania jak największej mocy wyjściowej 0,48 W przy nachyleniu 0°C i 0,56 W przy nachyleniu 30°C. (Modyfikacja projektu turbiny koła wodnego z różnymi wariantami konfiguracji)

Keywords: Blade, Water Wheel Turbine, Efficiency, Output Power, Configuration

Słowa kluczowe: Łopata, turbina koła wodnego, wydajność, moc wyjściowa, konfiguracja

Introduction

In current technological developments, electricity is essential for people's lives, both in households and industry [1]. The need for electrical energy has entered almost all aspects of life, including lighting, transportation, communication, information, and education. For this reason, electrical energy must be available so that activities that require electrical energy are not hampered [2]. One of the supporters of the provision of electrical energy is the availability of technology that can convert this energy source into electrical energy that the community can use. An electrical energy generator, especially steam power, requires several auxiliary systems that support the generation process [3]. There are various additional systems, such as cooling systems, pressurized oil systems, lubrication systems and other systems [4].

In technology, we can find several devices that function as heat releases, such as steam boilers, combustion chambers in combustion engines, heat exchangers and other cooling cycles. The cooling system is a series to overcome excessive heat on the engine so the machine can work stably [5]. In the cooling system, one of the components used is the condenser. In a Steam Power Plant system, the condenser functions as a means of exchanging and dissipating heat to the environment.

One of the obstacles in the open loop cooling system is that the seawater that will be discharged back to the source does not meet the quality standards for wastewater generation, so the wastewater pit requires a long channel construction. Construction of a long wastewater pit channel is needed, so that heat transfer by convection occurs in the water channel to achieve the temperature requirements of

the generated wastewater, which is around 30°C [6]. However, dissipating heat with long channels is not an effective method because it requires more costs, so innovations are needed in the application of a water wheel which functions to accelerate temperature reduction and decomposition of chemicals that are still contained in the wastewater. In addition to fulfilling the requirements for the quality standards for generated wastewater, this water wheel can also be used to generate power for lighting the Steam Power Plant area.

Studies on the utilization of water wheel turbines have been carried out previously, including [7, 8] which discusses the potential use of water wheel technology in turbines and hydroelectric power plants [9] discusses the flow and performance of waterwheel turbines using experimental and numerical analysis. [10] discusses the design of a waterwheel for a low-voltage MHP system. [11] discusses the Assessment of different types of waterwheels to improve the performance of wastewater pits. Through the application of water wheel turbines can be used to accelerate temperature reduction and chemical decomposition by installing fins on turbine blades [12]. However, in this study, the configuration of the fins on the turbine blades had not been varied. Based on this description, this study will change as many as four fin configurations, namely four-fin angled Λ shape, four-finned V-shaped, two parallel four-finned transverses (\equiv), and two parallel four-finned longitudinal (\parallel).

Research methods

The implementation of the activity begins with designing a wastewater pit, manufacturing and testing, as well as evaluating and perfecting the application of the

water wheel, and then data collection is carried out. The object of testing variations in the configuration of fins on water wheel turbines is a simulation of an open channel testing tool found in the Energy Conversion Laboratory of Ujung Pandang State Polytechnic. The measuring instrument used in this study is a flowmeter, and all measuring instruments are sensors attached to the test equipment. The material used in this test is the water heated to a temperature of 50 °C.

Data collection technique

Figure 1 shows the test scheme for data collection. Figure 2 shows the front view of the test scheme.

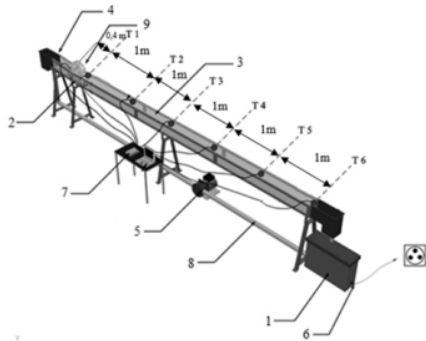

Fig 1. Test scheme

Information: 1. Container heater; 2. Generator; 3. Open channel; 4. Reservoir; 5. Pump; 6. Heater; 7. Controls; 8. Pipe; 9. Water wheel turbine, $T_1 - T_6$: Data Collection Point

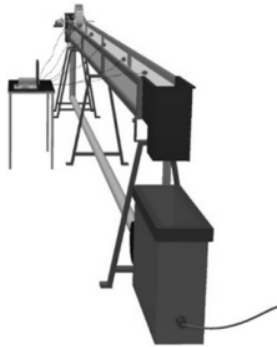

Fig 2. Front view of the test schematic

Figures 3 and 4 show the various fin configurations performed in this test.

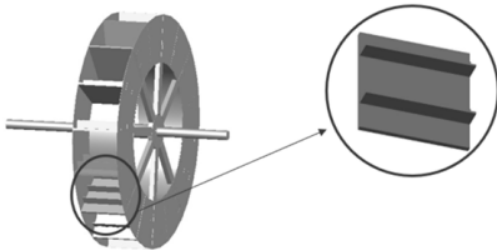

Fig 3. Water wheel turbine perspective

Data collection is carried out using Open Channel which has the following dimensions:

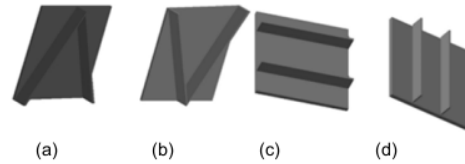

Fig 4. Four types of fin configuration variations on the blade (a) type 1: four-fin angled Λ shape, (b) type 2: four-fin angled V shape, (c) type 3: two transverse four-angled fins, (d) type 4: two parallel quadrilateral fins

Table 1. Geometry Dimensions of the Testing Equipment

Open Channel	
Specification	Dimensions
Channel Width (cm)	10
Length (m)	7
Height from the surface (m)	1,3
Fiber thickness (mm)	5
Dimensions of the triangular legs (cm)	4x8
Water Wheel Turbine	
Specification	Dimensions
Outer diameter (cm)	40
Inner diameter (cm)	24
Wide (cm)	8
Blade width (cm)	8
Blade Length (cm)	8
Number of blades	16 pieces

Placement of the water wheel in the waste water pit channel, which is 80 cm from the heater container, while the data or information needed in the test scheme is listed below:

- Fluid temperature before and after passing through the water wheel ($^{\circ}\text{C}$)
- Cross-sectional area (m^2)
- Flow speed (m/s)
- Hydraulic diameter (m)
- Water discharge (m^3/s)
- Water level (m)
- Generator voltage (V)
- Generator current (A)
- Generator speed (rpm)

Then collect the data above according to the variation of the test, which consists of the following:

- Test without using a water wheel
- Test using a water wheel (Fin type 1: four-fin angled Λ shape, type 2: four-fin angled V shape, type 3: two fins four-angled parallel transversely, type 4: two fins angled-four parallel longitudinally) as shown in Figure 3.

Furthermore, the above data is collected with a variety of tests, besides that the data above is needed to determine the type of flow and the rate of heat transfer by convection and is used to determine the amount of power generated from the generation of water wheels with a sinking blade depth of 3 cm at discharge 0.00349221 m^3/s , 2 cm at discharge 0.002739 m^3/s , 1 cm at discharge 0.001726 m^3/s .

After that, a test consisting of:

Testing using the water wheel

- Fins type 1: angular-four Λ shape
- Fins type 2: V-shaped four-angled fins
- Fins type 3: two parallel four-angled fins across
- Fins type 4: two parallel quadrilateral fins

Data Analysis Technique

The stages used in the data analysis technique are as follows:

- Input the data obtained from the test results in the form:
 - Fluid temperature after passing through the water wheel ($^{\circ}\text{C}$)
 - Cross-sectional area (m^2)
 - Flow speed (m/s)
 - Fluid density (kg/m^3)
 - Hydraulic diameter (m)
- Process the data that has been previously inputted to obtain data
 - The rate of heat transfer by convection (W)
 - Reynolds number
 - Prandtl's number
 - Nusselt number
 - Power generated from the water wheel
- Perform data analysis in the form of an evaluation of the calculation results obtained.
- Drawing conclusions based on the results of data analysis.

Research Result Data Analysis

Testing without Using a Water Wheel Turbine

By taking observational data on the test without using a water wheel using distance variations, data No. 3 in table 2 with a slope of 0° as an analysis reference.

Table 2. Data from temperature test results without using a water wheel turbine with a distance variation at a slope of 0°

No	Q (m^3/s)	T with a variation of the distance ($^{\circ}\text{C}$)							
		T_1	T_2	T_3	T_4	T_5	T_6		
1	0,001726	29	50	49,98	49,94	49,89	49,84	49,8	49,77
2	0,002739	29	50	49,98	49,92	49,87	49,82	49,79	49,75
3	0,003492	29	50	49,96	49,88	49,83	49,76	49,71	49,64

The following data are known:

$$\begin{aligned}
 Q &= 0,003492 \text{ m}^3/\text{s} \\
 v &= 0,632 \text{ m/s} \\
 P &= 7 \text{ m} \\
 P &= 0,115 \text{ m} \\
 b &= 0,12 \text{ m} \\
 T_1 &= 49,96 \text{ }^{\circ}\text{C} \\
 \bar{T} &= 49,79 \text{ }^{\circ}\text{C} \\
 \Delta T &= T_1 - \bar{T} = (49,96 - 49,79) \text{ }^{\circ}\text{C} = 0,163 \text{ }^{\circ}\text{C}
 \end{aligned}$$

Then,

- Hydraulic diameter, D_h

$$D_h = \frac{4A}{P} = \frac{4 \times 0,00552 \text{ m}^2}{0,115 \text{ m}} = 0,192 \text{ m}$$

- Reynolds number for open channel flow, Re

$$Re = \frac{\rho v D_h}{\mu}$$

Based on the Table of Physical Properties of Water, at $\bar{T} = 49,79^{\circ}\text{C}$ by means of interpolation obtained $\vartheta = 0,0005487 \frac{\text{kg}}{\text{m}} \cdot \text{s}$

Then,

$$Re = \frac{\rho v D_h}{\mu} = \frac{988,1 \frac{\text{kg}}{\text{m}^3} \times 0,632 \text{ m/s} \times 0,192 \text{ m}}{0,0005487 \frac{\text{kg}}{\text{m}} \cdot \text{s}} = 218746,759$$

- Prandtl Number, Pr

$$Pr = \frac{\mu C_p}{K}$$

Based on the Table of Physical Properties of Water, at $\bar{T} = 49,79^{\circ}\text{C}$ by means of interpolation obtained:

$$\begin{aligned}
 C_p &= 4181,5 \text{ kJ/kg} \cdot \text{K} \\
 K &= 0,640 \text{ W/m} \cdot \text{K}
 \end{aligned}$$

Then,

$$Pr = \frac{\mu C_p}{K} = \frac{0,0005487 \text{ m}^2/\text{s} \times 4181,5 \text{ kJ/kg} \cdot \text{K}}{0,640 \text{ W/m} \cdot \text{K}} = 3,582$$

- Nusselt Number, Nu

$$Nu = 0,023 \times Re^{0,8} \times Pr^n$$

$$n = 0,4 \text{ for cooling}$$

$$\begin{aligned}
 Nu &= 0,023 \times Re^{0,8} \times Pr^n \\
 &= 0,023 \times (218746,759)^{0,8} \times (3,582)^{0,4} \\
 &= 716,767
 \end{aligned}$$

- Convection Heat Transfer Coefficient, \bar{h}_c ($\text{W/m}^2 \cdot \text{K}$)

$$\begin{aligned}
 \bar{h}_c &= \frac{Nu K}{D_h} \\
 &= \frac{716,767 \times 0,640 \text{ W/m} \cdot \text{K}}{0,192 \text{ m}} = 2390,568 \text{ (W/m}^2 \cdot \text{K)}
 \end{aligned}$$

- Convection Heat Transfer Rate, q_c (W)

$$q_c = \bar{h}_c A \Delta T$$

Where:

$$A = B \times h$$

$$= 0,12 \text{ m} \times 0,046 \text{ m} = 0,00552 \text{ m}^2$$

Then:

$$\begin{aligned}
 q_c &= \bar{h}_c A \Delta T \\
 &= (2390,568 \text{ W/m}^2 \cdot \text{K}) \times 0,00552 \text{ m}^2 \times \\
 &0,163 \text{ }^{\circ}\text{C} = 2,1553 \text{ W}
 \end{aligned}$$

5

The results of other data analysis can be seen in Figures 5 to 10.

Testing by Using a Water Wheel Turbine

Dengan mengambil data pengamatan pada pengujian menggunakan turbin roda air dengan menggunakan variasi konfigurasi sirip, yaitu data No. 1 pada tabel 3 pada kemiringan 0° sebagai acuan analisa.

Table 3. Data on temperature test results using a water wheel turbine with four angled fins in the shape of Λ with a variation of the slope distance of 0° ($Q = 0,001726 \text{ m}^3/\text{s}$)

No	V (V)	I (A)	n (rpm)	Temp. dengan variasi jarak ($^{\circ}\text{C}$)					
				T1	T2	T3	T4	T5	T6
1	0,8	0,055	50	49,8	49,74	49,7	49,67	49,62	49,59
2	0,8	0,055	50	49,66	49,6	49,55	49,51	49,48	49,44
3	0,82	0,056	50	49,66	49,57	49,52	49,48	49,44	49,41
4	0,82	0,056	51	49,55	49,46	49,43	49,4	49,34	49,32
5	0,82	0,056	51	49,53	49,39	49,37	49,36	49,35	49,28

The following data are known:

$$\begin{aligned}
 Q &= 0,001726 \text{ m}^3/\text{s} \\
 v &= 0,714 \text{ m/s} \\
 P &= 7 \text{ m} \\
 P &= 0,115 \text{ m} \\
 b &= 0,12 \text{ m} \\
 h &= 0,020 \text{ m} \\
 T_1 &= 49,8 \text{ }^{\circ}\text{C} \\
 \bar{T} &= 49,68 \text{ }^{\circ}\text{C} \\
 \Delta T &= T_1 - \bar{T} = (49,8 - 49,68) \text{ }^{\circ}\text{C} = 0,113 \text{ }^{\circ}\text{C} \\
 V &= 0,8 \text{ V} \\
 I &= 0,055 \text{ A} \\
 n &= 50 \text{ rpm}
 \end{aligned}$$

In the same way as the previous calculation, we get:

- Hydraulic diameter, D_h

$$D_h = 0,084 \text{ m}$$

- Reynolds number for open channel flow, Re

$$Re = 107903,1857$$

- Prandtl Number, Pr

$$Pr = 3,5908$$

- Nusselt Number, Nu

$$Nu = 407,599$$

- Convection Heat Transfer Coefficient, \bar{h}_c ($\text{W/m}^2 \cdot \text{K}$)

$$\bar{h}_c = 3106,591 \text{ (W/m}^2 \cdot \text{K)}$$

- Convection Heat Transfer Rate, q_c (W)

$$q_c = 0,850 \text{ W}$$

- Input Power, $P_{in}(W)$

$$P_{in} = \rho \times g \times Q \times h$$

$$= 988,18 \text{ kg/m}^3 \times 9,81 \text{ m/s}^2 \times 0,001726 \text{ m}^3/\text{s} \times 0,020 \text{ m}$$

$$= 0,3367 \text{ W}$$
- Output Power, $P_{out}(W)$

$$P_{out} = V \times I$$

$$= 0,8 \text{ V} \times 0,055 \text{ A} = 0,044 \text{ W}$$
- Water Wheel Turbine Efficiency, $\eta_T (\%)$

$$\eta_T = \frac{P_{out}}{P_{in}} \times 100\%$$

$$= \frac{0,044 \text{ W}}{0,3367 \text{ W}} \times 100\% = 13,06\%$$

5 The results of other data analysis can be seen in Figures 7 to 14.

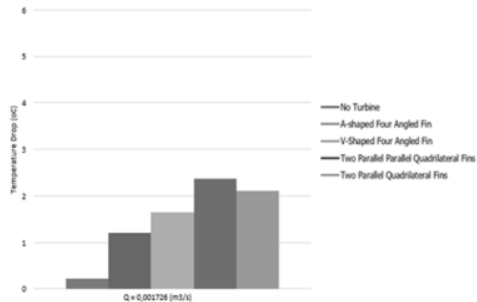

Fig 5. Temperature drop in the test using a water wheel with variations in fin configuration, $Q = 0.001726 \text{ m}^3/\text{s}$ slope 0°

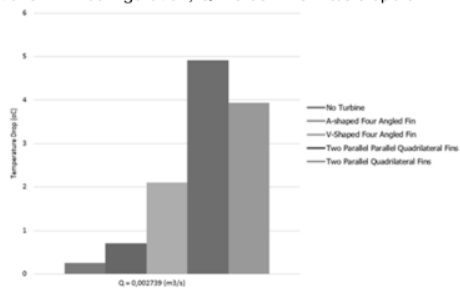

Fig 6. The temperature drop in the test using a water wheel with a variety of fin configurations, $Q = 0.002739 \text{ m}^3/\text{s}$ with a slope of 0°

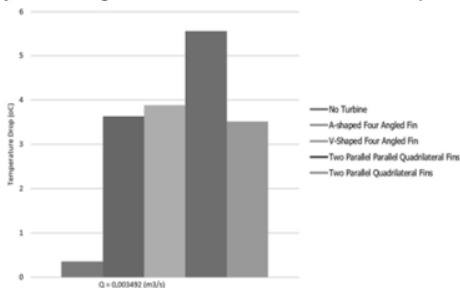

Fig 7. Temperature drop in the test using a water wheel with various fin configurations, $Q = 0.003492 \text{ m}^3/\text{s}$ slope 0°

Results and Discussion

Based on the results of the data analysis that has been carried out, a graph is made to see the magnitude of the temperature drop and the relationship between the value of efficiency and output power to rotation with different discharges at the Waste Water Pit without using a water wheel turbine and using a water wheel turbine with various configurations.

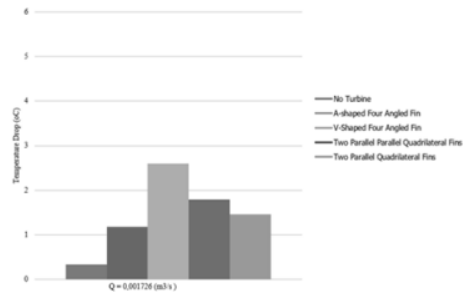

Fig 8. The temperature drop in the test using a water wheel with a variety of fin configurations, $Q = 0.001726 \text{ m}^3/\text{s}$ with a slope of 30°

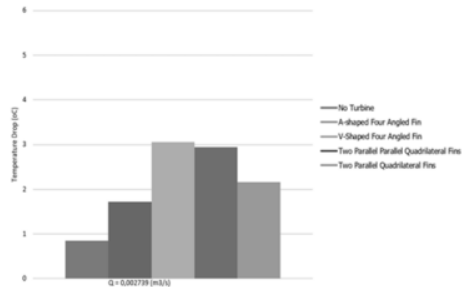

Fig 9. Temperature drop in the test using a water wheel with variations in fin configuration, $Q = 0.002739 \text{ m}^3/\text{s}$ slope of 30°

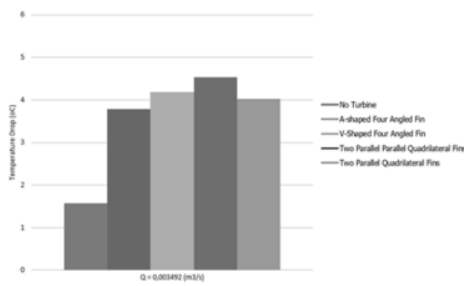

Fig 10. Temperature drop in the test using a water wheel with variations in fin configuration, $Q = 0.003492 \text{ m}^3/\text{s}$ slope 30°

It can be seen in Figures 5 to 10 the temperature drop in the test using a water wheel with a variation of the tilt fin configuration of 0° and 30° , that the temperature value after passing through the waterwheel turbine experiences a rapid decrease in temperature. This is influenced by the function of the water wheel turbine as an agitator (mixer), where fins are added to the turbine blades to speed up the temperature reduction process. The type of fin that lowers the temperature faster is at a slope of 0° , and the type of fin type Two Elbow-Four Elbow Parallel Transverse at $Q = 0.003492 \text{ m}^3/\text{s}$ has the most significant temperature drop value of 5.56°C . Without using a water wheel, it experiences a decrease in temperature, namely a maximum of only 0.36°C . Whereas at a slope of 30° , the type of fin type Two Elbow-Four Parallel Transverse Fins at $Q = 0.003492 \text{ m}^3/\text{s}$ has the most significant temperature drop value of 4.54°C , and without using a water wheel, it experiences a maximum temperature drop of 1.57°C . The decrease in temperature without using a water wheel is caused by the evaporation of water with the air temperature around the environment by using an open channel system

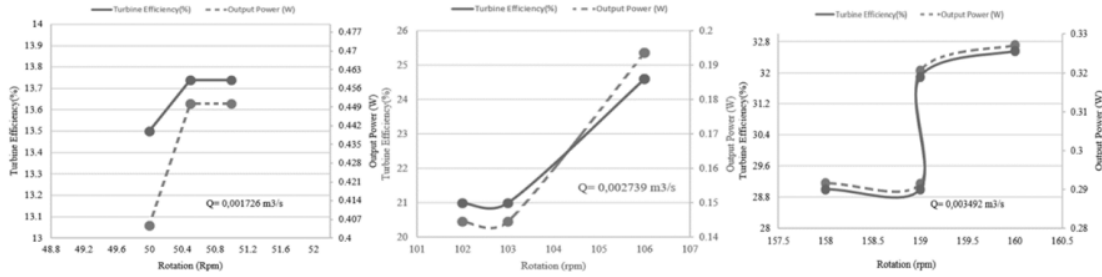

Fig 7. Correlation between rotation and turbine efficiency and output power on the four-angled Λ fin test tilted at 0°

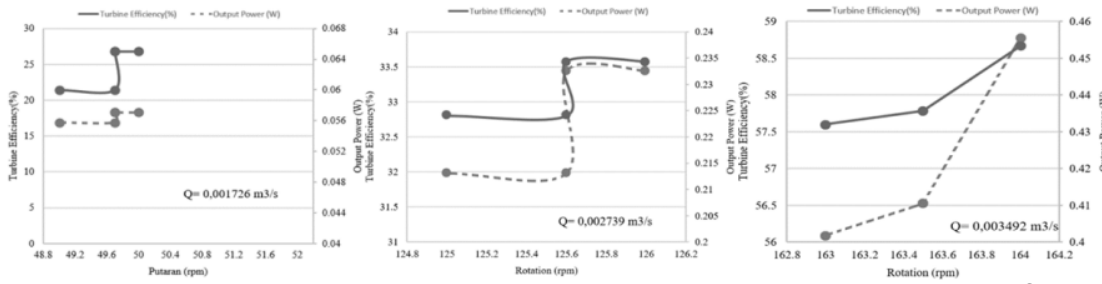

Fig 8. Correlation between rotation and turbine efficiency and output power on the four-angled V-shaped fin test with a slope of 0°

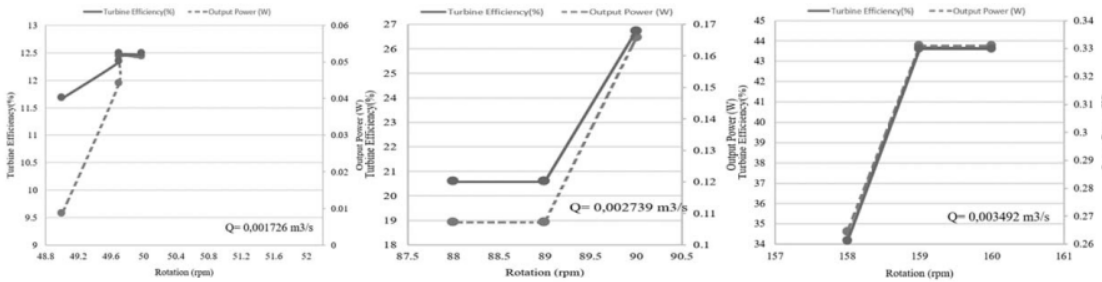

Fig 9. Correlation between rotation and turbine efficiency and output power in the test of two parallel four-angled fins with a slope of 0°

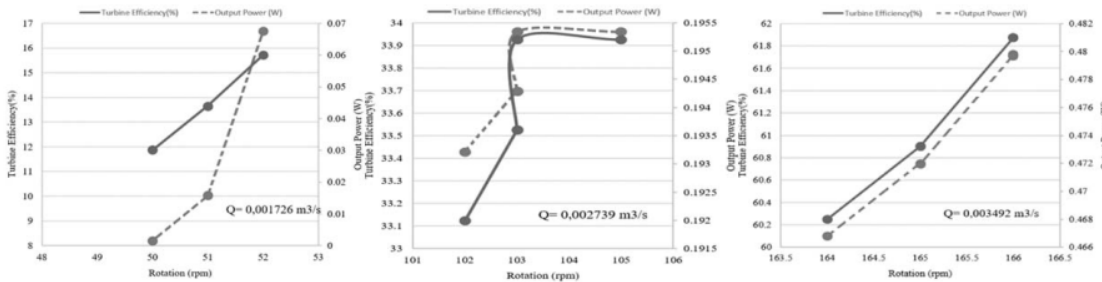

Fig 10. Correlation between rotation and turbine efficiency and output power in the test of two parallel four-angled fins with a slope of 0°

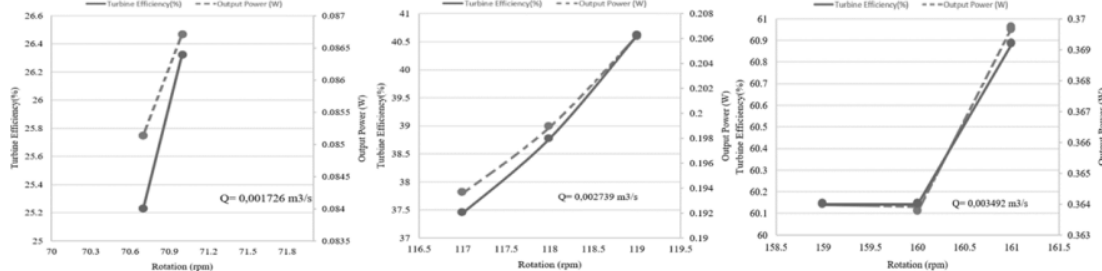

Fig 11. Correlation between speed and turbine efficiency and power output on the four-angle fin test with a slope of 30°

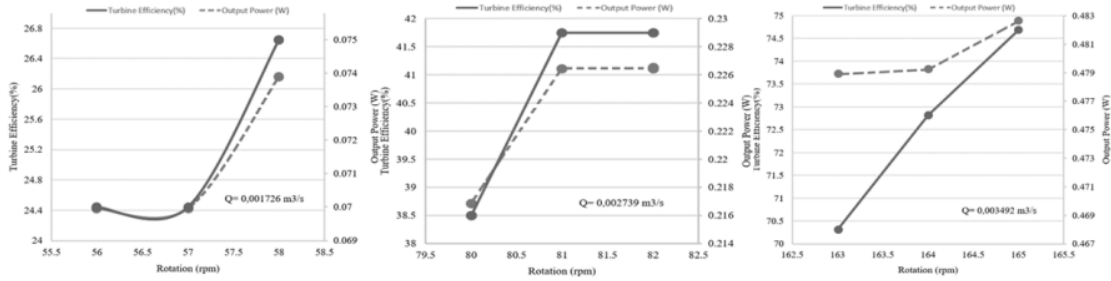

Fig 12. Correlation between rotation and turbine efficiency and output power in the V-shape angled fin test with a slope of 30°

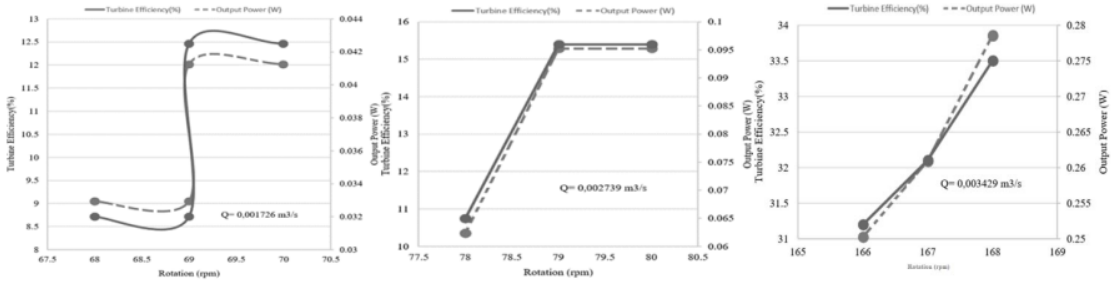

Fig 13. Correlation between rotation to turbine efficiency and output power in the test of two parallel four-angle fins across a slope of 30°

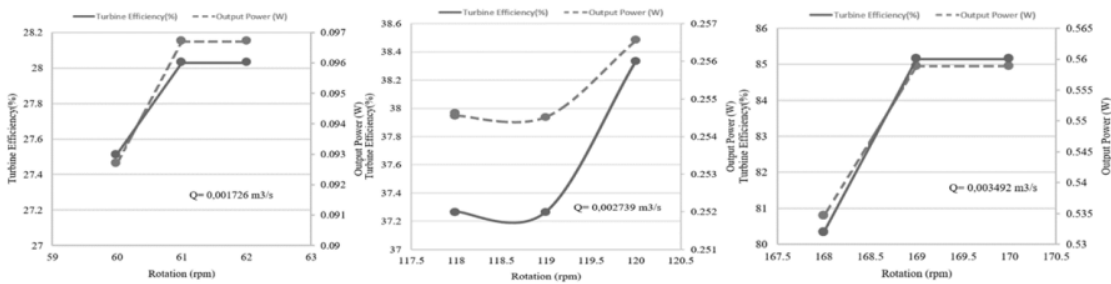

Fig 14. Correlation between rotation to turbine efficiency and output power in the test of two parallel four-angled fins longitudinally tilted at 30°

Figure 7 to Figure 14 shows the relationship between rotation on turbine efficiency and output power in testing variations of the tilt fin configuration 0° and 30° directly proportional where the greater the value of the rotation given, it affects the value of the turbine efficiency and power output. Based on the results of the graph above testing the type of two fins that parallels four angles longitudinally with a slope of 0°, the highest turbine efficiency value is 61.71%. The highest output power value is 0.481 watts, and at a pitch of 30°, the highest turbine efficiency value is 84.95%, and the highest output power value is 0.56 watts. This is because the influence of a large discharge produces a large turbine rotating speed where the water that crashes into a turbine only passes through the fin on the blade so that the water is not accommodated on the fins where it does not slow down the turbine rotation then the water wheel turbine that is copied with the generator produces efficiency value turbine and output power.

From Figure 15 to 18, the relationship between efficiency testing (%) and discharge (m³/s) with a variety of fin configurations in slope 0° and 30° can be seen that the greater the value of the release (m³/s), the greater the efficiency value (%) resulting from. This is because the amount of discharge is large. The value of the flow velocity (m/s) is also by the formula $Q = A \times V$, where the value of

the release is directly proportional to the flow rate so that the water hitting the turbine blades will produce a rotational speed to rotate the water wheel turbine which coupled with the generator. The most excellent efficiency is in the longitudinal parallel four-finger type of 61.71% at a slope of 0°. The longitudinal parallel four-angled fin type is 84.95% at a pitch of 30° with a state value of $Q = 0.003492 \text{ m}^3/\text{s}$.

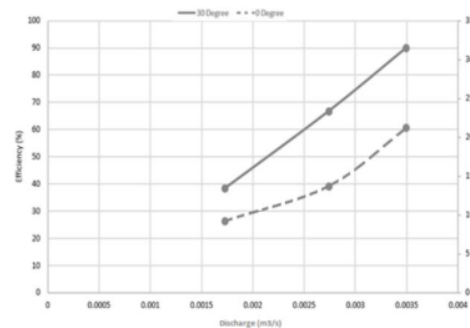

Fig 15. The relationship between testing efficiency (%) to discharge (m³/s) with the Elbow-Four Λ type at a slope of 0° and 30°

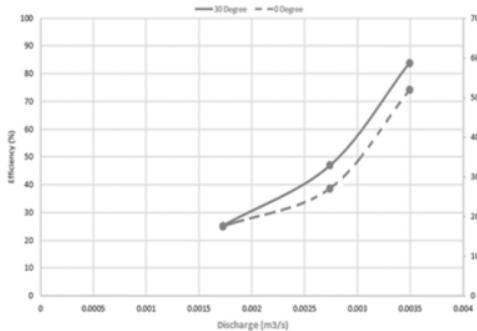

Fig 16. Correlation between testing efficiency (%) to discharge (m³/s) with the V-shaped Four Angled Fin type at a slope of 0° and 30°

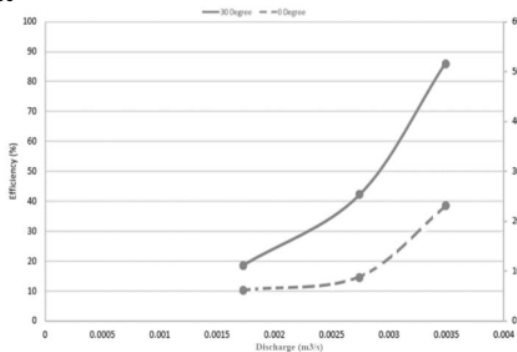

Fig 17. Correlation between testing efficiency (%) to discharge (m³/s) with the type of two Cross Parallel Four Angled Fins at a slope of 0° and 30°

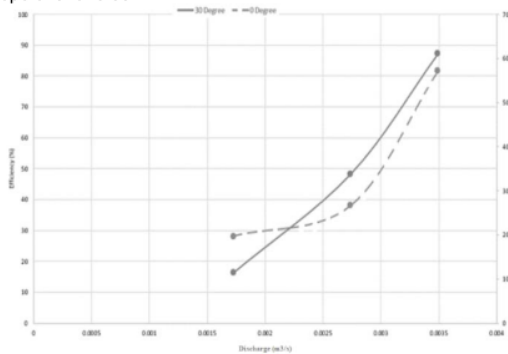

Fig 18. Correlation between testing efficiency (%) to discharge (m³/s) with longitudinal parallel four-finned type two fins at a slope of 0° and 30°

Conclusion

Based on the results of data analysis and discussion that has been carried out, it can be concluded that:

1. The performance of the water wheel turbine power plant produces efficiency and output power by utilizing a significant discharge value which will help water hit the turbine blades to have rotation coupled to the generator.

Variations in the configuration of the water wheel turbine fins with the type of two parallel four-angled fins have the highest efficiency at 0o slope of 61.71% and the highest efficiency at 30o slope is 84.95% with Q = 0.003492 m³/s. The highest value of output power (Watts) is 0.48 Watts at a slope of 0o and 0.56 Watt at a pitch of 30o.

2. Variations in the configuration of the fins of the water wheel turbine with the type of two parallel four-angled fins transverse to the blade have a fast temperature drop value with a temperature drop value of 5.56 oC on a slope of 0o and 4.54 oC on a slope of 30o with Q = 0.003492 m³/s.

REFERENCES

- [1] M. Marhatang and M. R. Djalal, "Optimal economic dispatch using particle swarm optimization in Sulselbar system," *IAES International Journal of Artificial Intelligence*, vol. 11, no. 1, pp. 221-228, 2022.
- [2] T. SZUL, "Evaluation of energy and economic efficiency of selected heating systems using electricity," *PRZEGLĄD ELEKTROTECHNICZNY*, vol. 12, pp. 250-253, 2022.
- [3] D. Kumar, R. A. Memon, A. G. Memon, I. A. Tunio, A. J. M. U. R. J. o. E. Junejo, and Technology, "Impact of Auxiliary Equipments' Consumption on Electricity Generation Cost in Selected Power Plants of Pakistan," vol. 36, no. 2, pp. 419-436, 2017.
- [4] B. Wang and Y.-z. Zhao, "Study on Condition Monitoring and Evaluation of Auxiliary Engine of Steam Turbine Based on Matter-element Theory," *IOP Conference Series: Earth and Environmental Science*, vol. 189, no. 5, p. 052028, 2018/11/01 2018.
- [5] A. K. Hossain, D. I. Smith, P. A. J. J. o. S. D. o. E. Davies, Water, and E. Systems, "Effects of engine cooling water temperature on performance and emission characteristics of a compression ignition engine operated with biofuel blend," vol. 5, no. 1, pp. 46-57, 2017.
- [6] F. Firman, R. D. Muhammad, K. Aznia, H. Taufiq, U. J. A. J. o. B. Fadilatul, and A. Sciences, "Water Wheel Turbine Performance as a Power Plant in Waste Water Pit PLTU System," vol. 2021, pp. 16-23, 2021.
- [7] P.-L. J. C. R. M. Viollet, "From the water wheel to turbines and hydroelectricity. Technological evolution and revolutions," vol. 345, no. 8, pp. 570-580, 2017.
- [8] E. Quaranta, R. J. R. Revelli, and S. E. Reviews, "Gravity water wheels as a micro hydropower energy source: A review based on historic data, design methods, efficiencies and modern optimizations," vol. 97, pp. 414-427, 2018.
- [9] M. H. Nguyen, H. Jeong, and C. J. S. C. T. S. Yang, "A study on flow fields and performance of water wheel turbine using experimental and numerical analyses," vol. 61, no. 3, pp. 464-474, 2018.
- [10] A. Zaman, T. J. J. B. S. Khan, and Technology, "Design of a water wheel for a low head micro hydropower system," vol. 1, no. 3, pp. 1-6, 2012.
- [11] Y. Klistafani, Firman, M. Anshar, and M. Yunus, "Assessment of various water wheel types to improve wastewater pit performance," in *AIP Conference Proceedings*, 2022, vol. 2543, no. 1, p. 060003: AIP Publishing LLC.
- [12] T. Hidayatullah and K. Aznia, "Analysis of the Performance of a Water Wheel Turbine with Dual Functions as a Power Generator and Agitator," Bachelor, Mechanical Engineering, Politeknik Negeri Ujung Pandang, Makassar, 2019.

Design Modification of Water Wheel Turbine With Various Configuration Variations

ORIGINALITY REPORT

9%

SIMILARITY INDEX

PRIMARY SOURCES

1	repository.poliupg.ac.id Internet	194 words — 5%
2	matematika.fmipa.unp.ac.id Internet	35 words — 1%
3	red.pe.org.pl Internet	33 words — 1%
4	www.red.pe.org.pl Internet	24 words — 1%
5	Mir Sikander Ali, Qadir Nawaz Shafique, Dileep Kumar, Summeet Kumar, Sanjay Kumar. "Energy and exergy analysis of a 747-MW combined cycle power plant Guddu", International Journal of Ambient Energy, 2018 Crossref	18 words — < 1%
6	scs.gmu.edu Internet	10 words — < 1%
7	worldwidescience.org Internet	9 words — < 1%
8	www.thuba.ch Internet	8 words — < 1%

EXCLUDE QUOTES OFF

EXCLUDE BIBLIOGRAPHY ON

EXCLUDE SOURCES OFF

EXCLUDE MATCHES OFF