

A Fish Feeding Robot Prototype with a Water Level Control System Using a Proportional – Integral Controller

By Abdul Kadir Muhammad

PAPER • OPEN ACCESS

A Fish Feeding Robot Prototype with a Water Level Control System Using a Proportional – Integral Controller

To cite this article: Abdul Kadir Muhammad and Dermawan 2022 *J. Phys.: Conf. Ser.* **2213** 012029

View the [article online](#) for updates and enhancements.

You may also like

- 11 [Electric Machines Virtual Laboratory: Testing of DC Motor](#)
R Badarudin, D Hariyanto, M Ali et al.
- 9 [Fish-inspired robots: design, sensing, actuation, and autonomy—a review of research](#)
Aditi Raj and Atul Thakur
- 4 [The lifting bifurcation problem on feed-forward networks](#)
Pedro Soares



ECS Membership = Connection

ECS membership connects you to the electrochemical community:

- Facilitate your research and discovery through ECS meetings which convene scientists from around the world;
- Access professional support through your lifetime career;
- Open up mentorship opportunities across the stages of your career;
- Build relationships that nurture partnership, teamwork—and success!

Join ECS!

Visit electrochem.org/join



A Fish Feeding Robot Prototype with a Water Level Control System Using a Proportional – Integral Controller

Abdul Kadir Muhammad and Dermawan

Center for Mechatronics and Control System, Mechanical Engineering Department,
State Polytechnic of Ujung Pandang

kadir.muhammad@poliupg.ac.id

Abstract. The purpose of this study is to develop a fish feeding robot prototype that equipped with a water level control system for pond use and to propose an effective control scheme for the robot prototype and the water level control system. The system used in this paper consists of a feed storage tank, a feed distribution mechanism, a feed ejection mechanism, an ejector position turning mechanism, a water level control system, a base and a solar panel system for energy sources. The three mechanisms used three DC motors as actuator, respectively. The water level control system used a water pump to pump water out of pond when the level of water exceeds the maximum level limit, and an ultrasonic sensor to measure the level of water in pond. On – Off and proportional – integral (PI) controllers used to control DC motors of the three mechanisms, and the water level control system, respectively. Performances of the robot prototype with the water level control system were examined through laboratory scale experiments. The result of the conducted experiments are presented and discussed.

2 Introduction

One of the fastest-growing food sectors in the world is aquaculture [1] [2]. In aquaculture activities, the frequency of feeding fish is very important because it will affect the amount of feed consumed, feed efficiency and the possibility of environmental contamination. Environmental pollution will affect the health and survival of fish. However, the current feeding activity is still mostly done manually so it is not effective because the distribution of feed is uneven and sometimes not on time. Furthermore, controlling of water level of pond is another important thing. Sometimes the water level rises after heavy rains which if handled too late can cause the pond to overflow, especially in tropical area.

In the last decade, a number of fish feeding automatic mechanism have been investigated by researchers Wei et al [3] and Osueke et al [4] designed automatic fish feeder machine that focused on design and construction. Nasir Uddin et al [5] investigated automatic fish feeder with water temperature monitoring whereas Balagi et al [6] investigate automatic fish feeding with pH and temperature monitoring. Karningsih et al [7] develop automatic fish feeding system for an offshore aquaculture unit. Furthermore, PID controller was widely used in robotic applications due to its effectiveness, not only in form of rigid but also flexible robots [8 – 14].

The purpose of this study is to develop a fish feeding robot prototype that equipped with a water level control system for pond use and to propose an effective control scheme for the robot prototype and the water level control system. The water level control system maintains level of water in pond from overflowing when it rains. Method to achieve the purpose was design and manufactures the robot as well as testing and refinement.

The system used in this paper consists of a feed storage tank, a feed distribution mechanism, a feed ejection mechanism, an ejector position turning mechanism, a water level control system, a base and a solar panel system for energy sources. The three mechanisms used three DC motors as actuator, respectively. The water level control system used a water pump to pump water out of pond when the level of water exceeds the maximum level limit, and an ultrasonic sensor to measure the level of water in pond. Finally, the performances of the robot prototype with the water level control system were tested in a laboratory scale environment.

2. Development a fish feeding robot with a water level control system

2.1. Mechanisms design

Figure 1 shows the model of the fish feeding robot prototype. The system of the robot consists of a feed storage tank, a feed distribution mechanism, a feed ejection mechanism, an ejector position turning mechanism, a water level control system, a base and a solar panel system for energy

Figure 2 and 3 show the three mechanisms and an experimental fish feeding robot prototype with a water level control system developed in this research. The mechanisms used a DC motor actuator respectively. The feed storage tank made of water drums with diameter of 38[cm] and height of 65 [cm]. On the lid of the tank, an ultrasonic sensor was installed to measure percentage of feed in the tank.

The feed distribution mechanism functions to regulate the flow of feed from the tank to the feed thrower according to the desired portion. The feed distribution mechanism consists of a valve, two cylinders as feed channel with diameter of 9 [cm] and height of 7 [cm], and a DC motor. The motor moved the valve from the point of drop of the feed to the input of the feed ejector with a rotation angle of 360 degrees in a clockwise direction. The motor would stop shortly after turning 180 degrees and then would rotate again. The valve served to move feed from the tank on and off, measured the portion of feed, and then led the feed to the ejector to be thrown into the pond. The quantity of feed can be set based on the number of rotations of 180°. The distribution mechanism also played a role in regulating the rhythm of the feed to be ejected so that there was no buildup in the ejection mechanism, and did not burden the ejector motor.

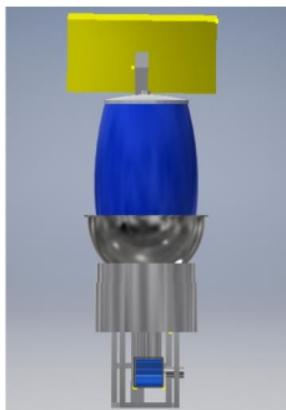

Figure 1. The 3-D model of the fish feeding robot prototype

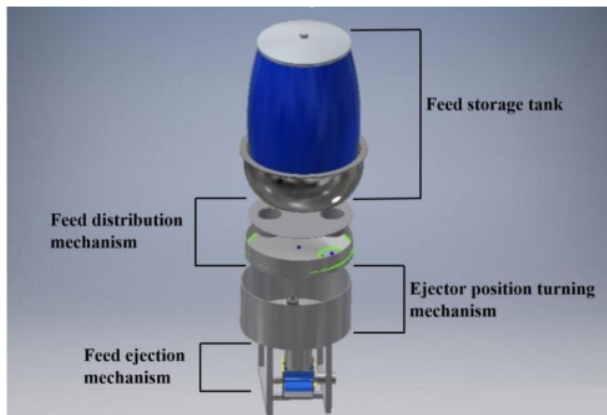

Figure 2. Feed storage tank and the three mechanisms of the fish feeding robot prototype.

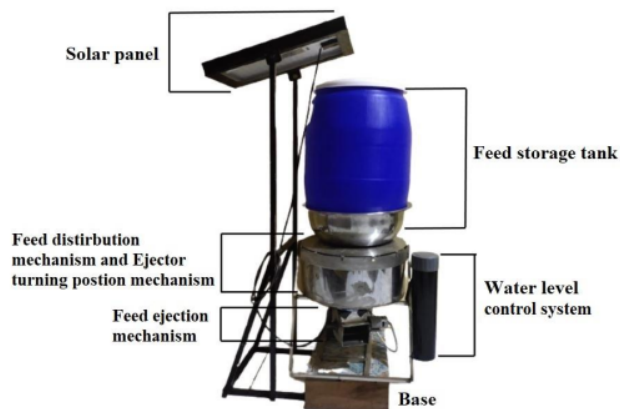

Figure 3. Experimental fish feeding robot prototype with a water level control system developed in this research.

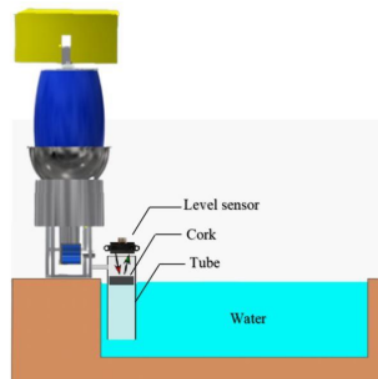

Figure 4. The water level control system.

The feed ejection mechanism consists of a planetary gear DC motor and used a propeller connected directly to the motor shaft to eject the feed. At maximum speed the ejector be able to throw up to 9 [m] forward. Furthermore, the ejector position turning mechanism functions to change the direction of the ejector by an angle of 90 degrees. To the right 45 degrees and to the left 45 degrees so that the feed can reach a wider area and make feeding evenly distributed. The ejector position turning mechanism consists of a cylinder with diameter of 9 [cm], a sprocket and a DC servo motor. The sprocket attached to the side while the lower end of the turning mechanism was connected to the ejection mechanism. The turning mechanism and the driving motor were connected using a chain so that they move in the direction of rotation of the driving motor. At the base, a sliding device was added to reduce friction when changing the direction of the ejector. The mechanism was actuated by the DC servo motor.

The charging process uses a 20 WP solar panel. A 12 [V] battery with a current of 7.5 [A] was used. The solar panel was connected to the charge controller. If the battery is fully charged then the solar panel charging automatically stops.

2.2. Water level control system

Figure 4 shows the water level control system developed in this research. The water level control system consist of a tube that was dipped to water and an ultrasonic sensor to measure the level of water in pond. A proportional – integral controller was designed to control the water level.

2.3. Configuration of control system

Figure 5 shows system configuration of the fish feeding robot prototype with the water level control system. The robot was controlled by ESP32 Module based on set point that set in computer. Three motor drivers were used to drive three DC motor that rotated for the three mechanisms. A relay was used to switch on and off the driver. A solar panel and a solar charge controller were used as the energy source system. A battery of 12 [V] was used to store power generated by the solar panel system. An adaptor with outputs of 5 [V] and 3 [V] was used to step down the voltage from the battery. A driver was used to drive the water pump of the water level control system. A relay was used to switch on and off the water level control driver. Level of water in pond was controlled by the ESP32 Module using the designed proportional – integral controller.

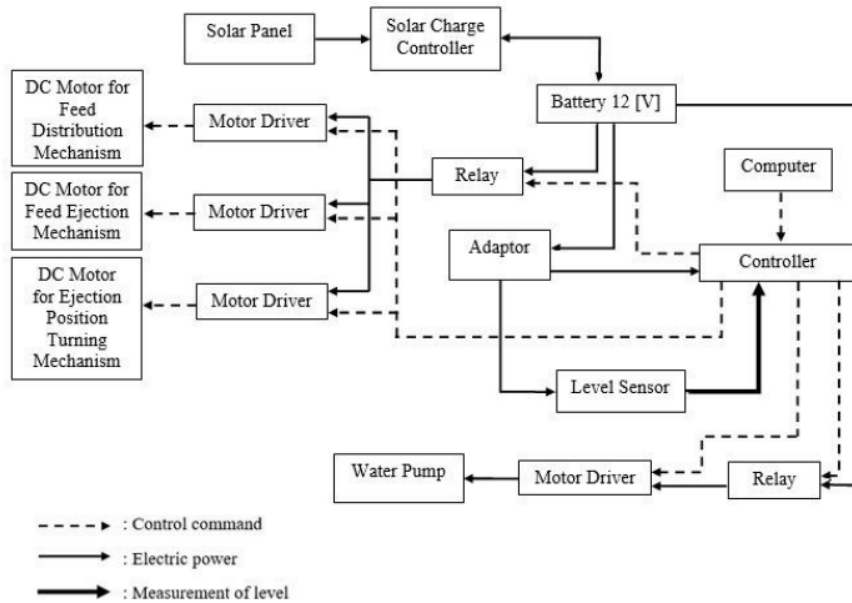

Figure 5. System configuration of the fish feeding robot prototype with a water level control system developed in this research.

3. Control Scheme

A control scheme was designed to control the fish feeding robot with the water level control system. A simple on – off controller with three pulse width modulation (PWM) signals was used to drive the three DC motors for the three mechanisms simultaneously. The on – off controller was selected to use because the fish feeding system was set based on schedule for feeding fish. A proportional – integral (PI) controller was designed to drive the water pump in order to keep the water of the pond in certain level. Controlled torque of the water pump is defined as follows

$$\tau = k_p \left((y - y_d) + \frac{1}{T_i} \int (y - y_d) dt \right) \quad (1)$$

where k_p is proportional gain and T_i is integral time. Desired and actual levels of water in the pond are denoted by y_d and y , respectively.

4. Experiments

4.1. Experimental Method

The experiment was conducted on a horizontal surface. The experiment goal was to examine the performances of the robot in term of mass of ejected feed, feed throw distance and water level control system. The first experiment was conducted to test performance of the robot in term of mass of ejected feed. Two containers were installed alternately under the distribution feed mechanism to accommodate the outgoing feed. The feed was then weighed to determine the mass of feed that comes out. This experiment was carried out for 1 [minute] with a sampling time of 10 [seconds]. Each sample taken was then weighed.

The second experiment was conducted to examine the performance of the robot in terms of feed throw distance. The Robot prototype ejected the feed while rotating 45 degrees to the right and 45

degrees to the left. This experiment was carried out for 1 [minute] with a sampling time of 10 [seconds]. Feed throw distance was measured every 1 sample.

The third experiment was conducted to examine the performance of the water level control system. The system was given a step of 1 [V]. Performance of the water level was examined in uncontrolled and controlled responses.

4.2. Experimental Results

Figure 6 shows the performance of the robot prototype in term of mass of ejected feed. It can be seen in figure 6 that masses of ejected feed are consistence in range of 183 [g] to 185 [g]. Figure 7 shows the performance of the robot prototype in term of feed throw distance. It can be seen in figure 7 that feed throw distances are consistence in range of 5.5 [m] to 5.8 [m].

Examining several gains of the PI-controller led to $k_p = 3 [-]$ and $T_i = 70 [s]$ as the better ones. Figure 8 shows the experimental time history responses of uncontrolled and controlled water level system. It can be seen in figure 9 that settling time for 90 % of final value is approximately 22 seconds and the steady state error is zero.

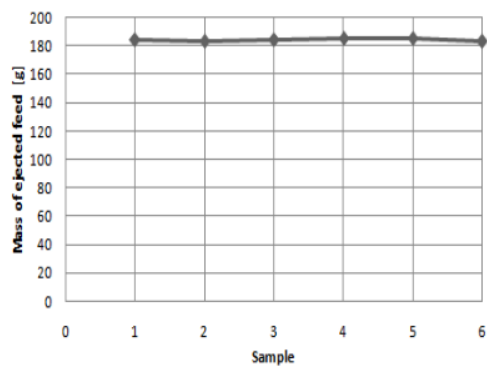

Figure 6. Mass of ejected feed experiment performance of the fish feeding robot prototype.

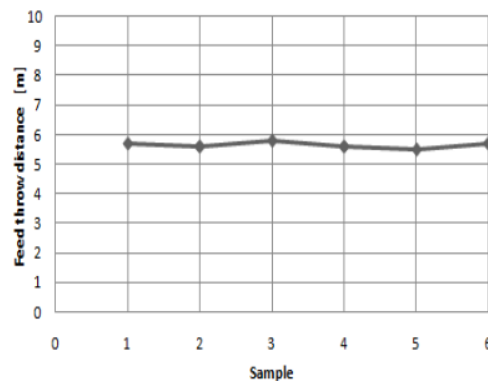

Figure 7. Feed throw distance experiment performance of the fish feeding robot prototype.

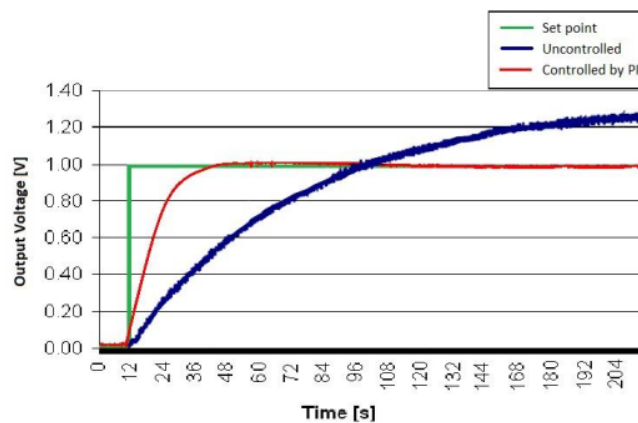

Figure 8. Experimental time history responses of the uncontrolled and controlled water level system.

5. Conclusion

In this present study, the fish feeding robot prototype with the water level control system and solar panel system was developed. Three mechanisms namely the feed distribution mechanism, the feed ejection mechanism and the ejector position turning mechanism which are main part of the feeding system, and the water level control system were developed and controlled effectively. The proposed control scheme using on – off and proportional – integral controllers was designed to control the fish feeding and the water level systems. Performances of the robot prototype with the water level control system were tested through laboratory scale experiments. The experimental results revealed that all systems can work consistently.

References

- [1] Ogunlela A O and Adebayo A A 2016 Development and performance evaluation of an automatic fish feeder *J. Aquac. Res. Dev.* **7**, No. **2**
- [2] Liao I C 2001 Trends and perspectives in Asian aquaculture *Report of The APO Seminar*.
- [3] Wei H C et al 2017 Improvement of automatic fish feeder machine design, *IOP Conf. Series: Journal of Physics* **914**
- [4] Osueke O C et al 2016 Design and construction of an automatic fish feeder machine *Int. J. Mech. Eng Tech* **10**1631
- [5] Nasir Uddin Md et al 2016 Development of an automatic fish feeder *Global J. Res. Eng* **16** No. **2**
- [6] Balaji A S et al 2020 Automatic fish feeding and monitoring system for aquarium using 555 timers *Int. J. Tech. Res. Sci* **5** No. **6** 20
- [7] Kamingsih P D et al 2020 Automated fish feeding system for an offshore aquaculture unit *IOP Conf. Series: Material Sci. Eng* **1072**
- [8] Khan H et al 2021 Control of an assistive robot for paraplegics using PID controller with sliding perturbation observer *Int. J. Mech. Eng. Robot. Res.* **10** No. **4** 196
- [9] Widhiada W et al 2020 Control of bionic robot leg performance with proportional integral and derivative controller *Int. J. Mech. Eng. Robot. Res.* **9** No. **10** 1447
- [10] Muhammad A K et al 2019 Experiments on motion and oscillation controls on a gantry crane system using parallel proportional controllers *IOP Conf. Ser: Mater. Sci. Eng.* **619** 01207
- [11] Muhammad A K et al 2014 Comparison of proportional and active-force controls on vibration of a flexible Link Manipulator using a piezoelectric actuator through calculations and experiments *Eng. Lett.* **22** No.3 134
- [12] Muhammad A K et al 2015 Computational simulations and experiments on vibration control of a flexible two-link manipulator using a piezoelectric actuator *Eng. Lett.* **23** No.3 200
- [13] Muhammad A K et al 2014 Comparison of proportional-derivative and active-force controls on vibration of a flexible single-link manipulator using finite-element method *Artif. Life Robot.* **19** No.4 375
- [14] Muhammad A K et al 2014 Computer simulations and experiments on vibration control of a flexible link manipulator using a piezoelectric actuator *Lect. Notes Eng. Comput. Sci.* 262

Acknowledgment

This work was supported by Ministry of Education, Culture, Research and Technology, Republic of Indonesia, with Grant Number of 099/E4.1/AK.PT/2021.

A Fish Feeding Robot Prototype with a Water Level Control System Using a Proportional – Integral Controller

ORIGINALITY REPORT

14%

SIMILARITY INDEX

PRIMARY SOURCES

1	repository.uin-suska.ac.id Internet	50 words — 2%
2	repository.futminna.edu.ng:8080 Internet	36 words — 2%
3	repository.usd.ac.id Internet	36 words — 2%
4	Manuela Aguiar, Ana Dias, Pedro Soares. "Towards a classification of networks with asymmetric inputs", <i>Nonlinearity</i> , 2021 Crossref	25 words — 1%
5	Jianqun Lin. "Labview and Internet Based Remote Water Level Control Laboratory", 2007 First IEEE International Symposium on Information Technologies and Applications in Education, 11/2007 Crossref	24 words — 1%
6	iopscience.iop.org Internet	22 words — 1%
7	yoran.office.ehime-u.ac.jp Internet	20 words — 1%
8	referencecitationanalysis.com	

Internet

19 words — 1%

9 repository.lppm.unila.ac.id

Internet

19 words — 1%

10 repository.tudelft.nl

Internet

18 words — 1%

11 www.semanticscholar.org

Internet

14 words — 1%

12 Jia, G.W.. "Performance of a large-scale slope model subjected to rising and lowering water levels", Engineering Geology, 20090528

Crossref

12 words — 1%

13 www.sist.in

Internet

11 words — < 1%

14 iaset.us

Internet

10 words — < 1%

15 Hanlin Liu, Oscar Curet. "Swimming performance of a bio-inspired robotic vessel with undulating fin propulsion", Bioinspiration & Biomimetics, 2018

Crossref

8 words — < 1%

16 www.coursehero.com

Internet

8 words — < 1%

17 Wei Wang, Han-Xiong Li, Jingtao Zhang. "Intelligence-based hybrid control for power plant boiler", IEEE Transactions on Control Systems Technology, 2002

Crossref

6 words — < 1%

EXCLUDE QUOTES OFF

EXCLUDE BIBLIOGRAPHY ON

EXCLUDE SOURCES OFF

EXCLUDE MATCHES OFF