

Assessment of various water wheel types to improve wastewater pit performance

By Yiyin Klistafani

8

Assessment of various water wheel types to improve wastewater pit performance

5

Cite as: AIP Conference Proceedings 2543, 060003 (2022); <https://doi.org/10.1063/5.0094903>

Published Online: 16 November 2022

Yiyin Klistafani, Firman, Muhammad Anshar, et al.



View Online



Export Citation

Trailblazers. New

Meet the Lock-in Amplifiers that measure microwaves.

Zurich Instruments [Find out more](#)

5

AIP Conference Proceedings 2543, 060003 (2022); <https://doi.org/10.1063/5.0094903>

2543, 060003

© 2022 Author(s).

Assessment of Various Water Wheel Types to Improve Wastewater Pit Performance

Yiyin Klistafani^{1,a)}, Firman^{1,b)}, Muhammad Anshar^{1,c)}, and Muhammad Yunus^{1,d)}

¹Mechanical Engineering Department, State Polytechnic of Ujung Pandang, Makassar, Indonesia

^{a)}Corresponding author: yiyin_klistafani@poliupg.ac.id

^{b)}firman@poliupg.ac.id

^{c)}muh_anshar@poliupg.ac.id

^{d)}yusuf_yunus@poliupg.ac.id

Abstract. Disposal of heat from wastewater power plants using long channels (wastewater pit) is one of the ways that can be used to achieve the requirements for the standard quality of wastewater. The purpose of this study was to determine the characteristics of fluid flow in the wastewater pit of the power plant system which is equipped with water wheels with fins. The other aims of the study are to determine the fins effect on the performance of the water wheel applied to the wastewater pit and to find out the difference in temperature reduction of wastewater in a wastewater pit with and without a water wheel. The method of the research is composed of experimental methods and numerical methods. An experimental study was carried out by taking data on a prototype wastewater pit. While the numerical method is performed using the Computational Fluid Dynamics (CFD) method with the Ansys Fluent 2020 R1 software. Based on the research results obtained a water wheel has a positive effect in reducing wastewater temperature compared to a channel that is not equipped with a water wheel. The two fins transverse Parallel water wheel shows the highest improvement of reducing wastewater temperature around 5.564%. The difference temperature drop that can be generated between two-fins transverse parallel water wheel and without water wheel is 2.422°C. The computational results obtained from the present studies are in good agreement with the experimental data for the case of a wastewater pit without a water wheel.

INTRODUCTION

The cooling system used in the power plant mostly uses seawater as a working fluid on the cooling media. The cooling system is a series to overcome the overheating (excessive heat) on the equipment so that the equipment can work stably [1]. One vital component of a power plant that requires seawater as a cooling medium is a condenser. The condenser uses seawater as a cooling medium to convert the vapor phase that has passed through the LP turbine into a liquid phase which is then flowed to hot well to be circulated so that the condensation results can be reused in the next process. Before seawater enters the intake, a chemical form of chlorine is injected to inhibit the growth of microorganisms and also avoid fouling [2]. The system used in this process is an open-loop so that seawater has been utilized will be discharged back to its source. There are several types of wastewater disposal processes that can be used in power plants with open-loop cooling systems including surface disposal, subsurface disposal, and diffusion disposal. Among the three types of processes, the surface disposal process is the most widely used in PLTU. Process waste heat in large power generation plants is commonly rejected to lakes or rivers. Although these waste heat rejection methods are effective, they may not be feasible in every application due to cost considerations or geographic location. The cooling canals reject heat through a combination of convection and radiation heat transfer as well as evaporation of canal water. The performance of a single canal is analyzed by discretizing into increments along the flow path. The water in the canal is assumed to be well mixed from the surface to the bottom of the canal [3]. Frediani [4] evaluated cooling canals system in Turkey Point. He showed that 4.7 GW of heat could be rejected from the system consisting of 32 outflowing canals and seven return canals. Each canal is 8380 m long and 90 m wide.

7

The Proceedings of the 4th EPI International Conference on Science and Engineering (EICSE) 2020

AIP Conf. Proc. 2543, 060003-1-060003-7; <https://doi.org/10.1063/5.0094903>

Published by AIP Publishing, 978-0-7354-4358-7/\$30.00

060003-1

The quality of the cooling water to be used as a cooler must achieve the requirements in accordance with the components or structures formulated in the cooling water quality specifications. The main problem that always arises from the activities of the cooling water system results from the Cooling Water System is the temperature of the wastewater from the system is much higher than the temperature of the surrounding environment [5]. Regulations regarding wastewater discharged from a plant, especially for steam power plants (PLTU), there are two parameters that must be considered, namely the increase in temperature and the chlorine content of wastewater a generation [6]. One of the obstacles in the open-loop cooling system is that seawater that is about to be discharged back to its source does not meet the requirements for the quality standard of generation wastewater, especially the high water temperature. Wastewater pit requires a long channel construction in order to reduce the temperature of the fluid. The construction of a long wastewater pit channel is needed so that convection heat transfer occurs in the water channel to reach the temperature required for the generation of wastewater which is around 30°C [7]. Heat waste (hot water) which is the result of the cooling process of the plant which must be discharged into the sea (cooling the residual steam from the turbine which is absorbed by cooling water) certainly has a very high temperature. During the PLTU design period, the possibility of heat had been thought, so that to overcome this, 1,300 m of cooling water channels (canals) were made to give the opportunity to reduce the temperature of the wastewater so that it could be reduced as low as possible (<2°C) [8].

Discharge of heat by using a long channel is one of the ways that can be used to achieve the requirements for the standard quality of wastewater. However, the disposal of heat with a long channel is not an effective way because it requires more cost so that new innovations are needed in the form of the application of the water wheel that serves to accelerate the reduction in the temperature of wastewater.

Various types of fin types will be applied in this study. The type of water wheel fins greatly determines the rotation speed on the water wheel. This certainly affects the characteristics of the fluid (wastewater) that is formed in the wastewater pit. The study of fluid flow characteristics in the wastewater pit becomes very important to be done in order to determine the effectiveness of the performance of the water wheel in reducing the temperature of wastewater from the power plant waste to the sea.

With the development of computer technology, it is possible to model engineering problems using computational Fluid Dynamics (CFD) approaches [9]. Different types of simulations have been compared and validated against experimental data. The simulations range from the 3D Reynolds-Averaged Navier-Stokes (RANS) approach. For most numerical simulations, the first step is meshing the simulation region. When the object to be simulated is solid or fluid in pipes, meshing is not difficult. But when it comes to water in open channels, especially when the surface of water varies, figuring out the position of the water surface is not an easy job [10].

Based on the explanation, it is very interesting to note that the design of the various water wheel types is one of the factors that affect the effectiveness of water wheels applied in wastewater pit systems in reducing the temperature of wastewater from power plants. The present study is a combination of experimental activity with numerical simulation. In this study, various water wheel types will be tested. Fins added to the water wheel are expected to be able to increase turbulence/water treatment around it, that's why it has a positive impact on temperature reduction.

The purpose of the conducted study is to determine the characteristics of fluid flow in the wastewater pit of the Power Plant system which is equipped with water wheels with various types of fins, determine the effect of the water wheel types on the performance of the water wheel applied to the wastewater pit of the Power Plant system. The computed results will be compared against available experimental data to show the fundamental capability of the model for predicting complex turbulent flows.

METHOD

Experimental Method

The experimental apparatus used was an open channel. The designed to adjust field data related to the structure and dimensions of wastewater pit in a power plant system. Water wheels are installed in the wastewater pit at a predetermined distance. These structures are illustrated in Fig. 1. Detailed information about their dimension is given in Table 1. The present studies investigate the effect of four different types of the water wheel, namely two fins transverse parallel, two fins longitudinal parallel, V shape fin, and A shape fin. Four different types of water wheels can be seen in Table 2.

Numerical Method

In the present section, the detailed description of the employed methods is given. The CFD studies mainly concern the flow through wastewater pit attached with the water wheel. A transient three-dimensional approach was employed for the present studies. It will be shown that this is sufficient for predicting the main flow features. The geometry was created using the Ansys workbench.

Numerical studies are carried out based on reference to experimental data that has been carried out as simulation input values in the software. The geometric drawing is adjusted to the dimensions of the experimental instrument in the experimental study. The results of the geometry and mesh using Ansys Workbench 2020 R1 can be seen in Fig. 2. Making the mesh is done using a hex dominant method and edge sizing so that the mesh is tighter in certain areas, especially near walls [9,11,12]. The water wheel mesh and zoom mesh of the wastewater pit can be seen in Fig. 3. The computations were carried out using the commercial software Ansys Fluent 2020 R1. The flow was transient. The boundary condition of the inlet was pressure inlet with initial velocity and temperature of flow was 0.582 m/s and 50°C. The boundary condition of outlet was the pressure outlet.

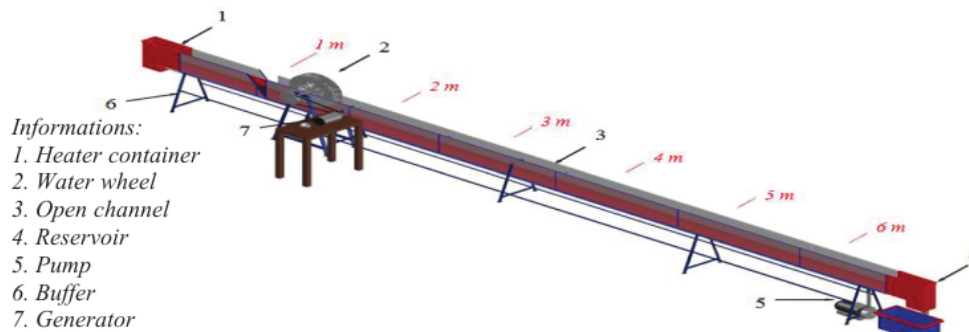

FIGURE 1. Wastewater pit with water wheel construction

TABLE 1. Wastewater pit dimensions

Specifications	Dimensions (m)
Width of channel	0.1
Length of channel	7
Height of channel	0.27
Height from based fiber thick	1.3
Buffer dimension	0.01
	0.04 × 0.08

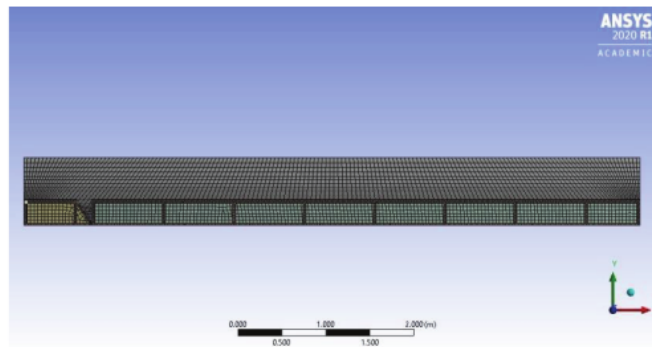
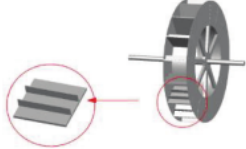
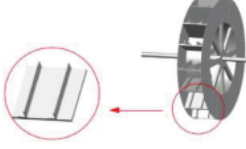
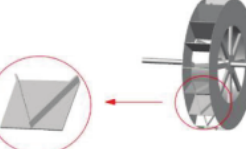
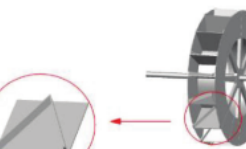

FIGURE 2. Computational domain and mesh of wastewater pit without water wheel

TABLE 2. Water wheel types

No.	Dimensions Water Wheel Types	3D Designs
1.	<i>Two fins transverse parallel</i>	
2.	<i>Two fins longitudinal parallel</i>	
3.	<i>V shape fin</i>	
4.	<i>Λ shape fin</i>	

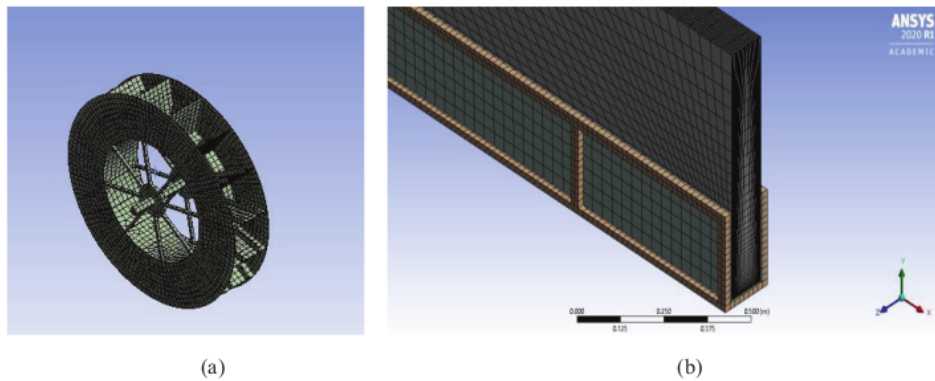

FIGURE 3. (a) Water wheel mesh and (b) Zoom mesh of wastewater pit

Grid independence studies were carried out in advance to ensure that the results are independent of the mesh resolution. The results are described in Table 3, where the temperature distribution of the four meshes is compared. It can be seen that grid 2 has a good agreement with experimental results with a relative error of about 0.34%.

TABLE 3. Grid independence

x/L		0.13	0.29	0.44	0.59	0.74	0.89	Average Error (%)	
Experiment		49.96	49.88	49.83	49.76	49.71	49.64		
T(°C)	Numeric (simulation)	Grid 1 (305413 cells)	64.477	66.023	63.891	67.305	70.5	73.09	35.660
		Grid 2 (349576 cells)	50	50	49.91	49.93	49.972	49.983	0.340
		Grid 3 (399858 cells)	50	50	50	50	50	50	0.408
		Grid 4 (449825 cells)	50	50	50	50	50	50	0.408
		Grid 5 (501336 cells)	49.998	50	50.001	50.001	50.001	50.001	0.409

RESULTS AND DISCUSSION

The experimental results of the effectiveness of using a water wheel at the wastewater pit on the value of reducing the wastewater temperature can be seen in Fig. 4. Based on the experimental results (Fig. 4), the water wheel has a positive effect in reducing fluid temperature compared to a channel that is not equipped with a water wheel (the initial temperature of wastewater is 50 °C). The type of water wheel that has the best performance is the two fins transverse Parallel water wheel. The resulting decrease in the final temperature reached 5.564% (around 2.782°C). When compared to the wastewater pit without water wheels, the final temperature decrease is only 0.72%. The V shape fin water wheel can reduce the final temperature of wastewater by about 3.876%, while for the two fins longitudinal parallel type and Λ shape fin, the performance is not too much different, which can reduce the final temperature about 3.524% and 3.636%.

The PLTU designed a canal for cooling wastewater with a very long construction in order to reduce the wastewater temperature by 2°C [6]. Therefore, using a water wheel is proven to have a significant temperature reduction effect when compared to a wastewater pit without a water wheel. The channel for cooling wastewater does not need very long channel construction if using a water wheel because of its significant effectiveness. The difference temperature drop that can be generated between two-fins transverse parallel water wheel and without water wheel is 4.844% (around 2.422°C). This indicates that the addition of wheel water can improve wastewater pit performance.

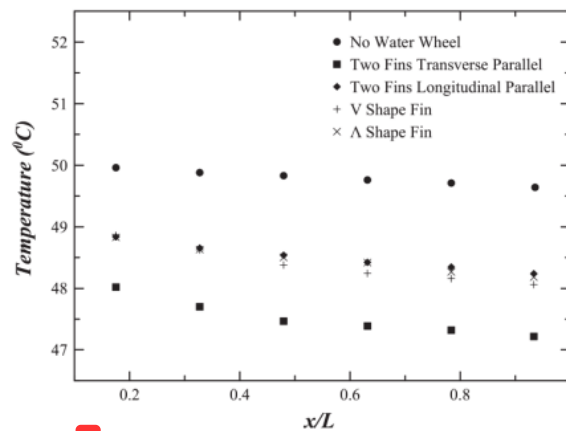

FIGURE 4. Temperature distributions at the midline axis along the axial positions for experimental results

Numerical results compared with experimental results for temperature distributions at the midline axis along the axial positions of wastewater pit shown in Fig. 5. The first case is a wastewater pit without a water wheel that is shown in Fig. 5 (a). There is no significant difference in results between experiment and simulation result, based on Fig. 5 (a). The simulation results, in this case, show that the wastewater temperature is not decreased significantly and even has a slight increase in temperature. An interesting fact from the other simulation results is decrement temperature of

the wastewater pit did not happen for two cases (just constant at 50°C), namely case wastewater pit with two fins transverse parallel and Λ shape fin types water wheel. Whereas for those cases, the experimental results showed decrement temperature. In the case of two fins longitudinal parallel and V shape fin water wheel, the simulation results show fluctuating temperature distribution values. This is certainly different from the experimental results which always show a continuous decrease in temperature. Based on the simulation results, it can be seen that the addition of a water wheel has no significant effect in reducing the wastewater temperature (as shown in Fig. 6).

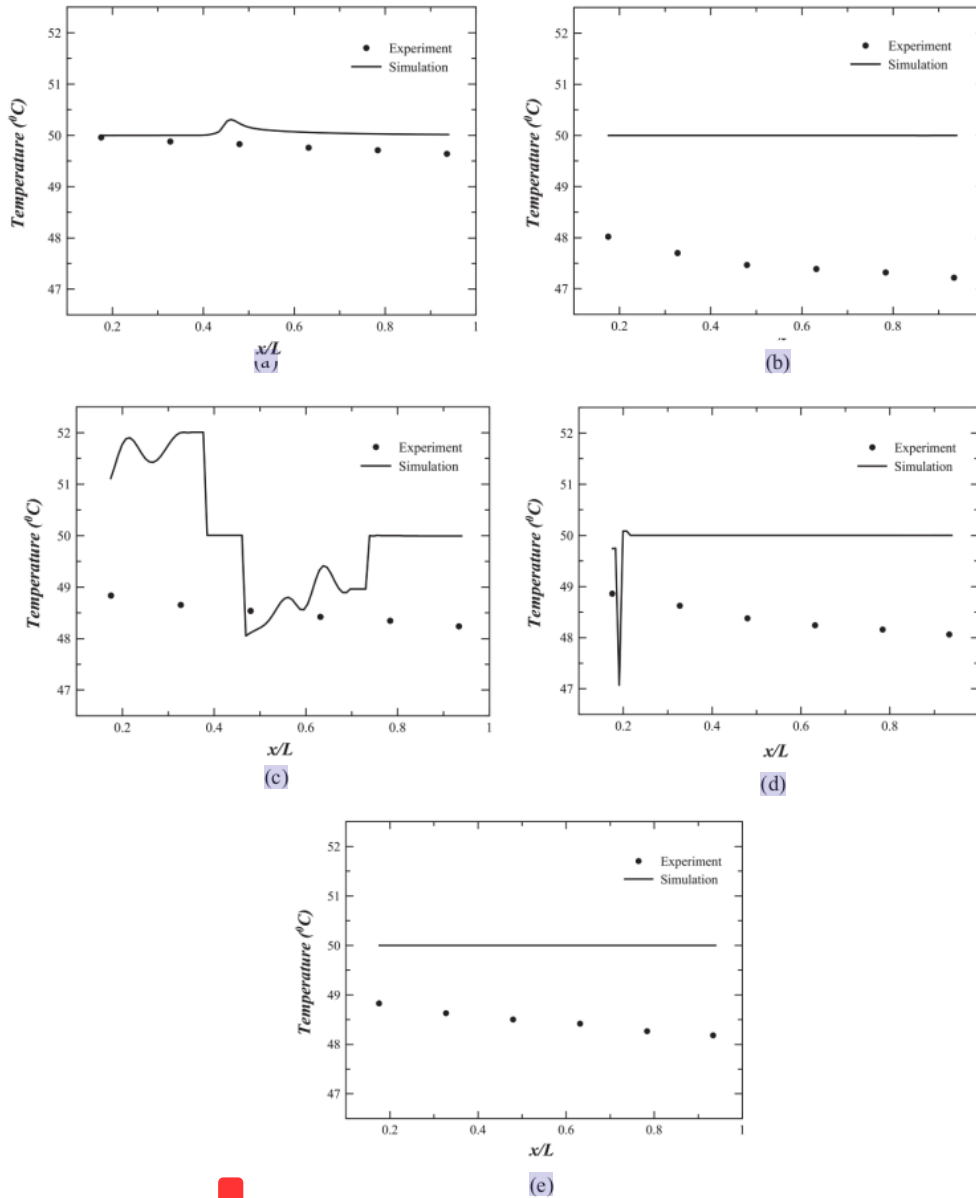

FIGURE 5. Temperature distributions at the midline axis along the axial positions for (a) no water wheel, (b) two fins transverse parallel, (c) two fins longitudinal parallel, (d) V shape fin, and (e) Λ shape fin type

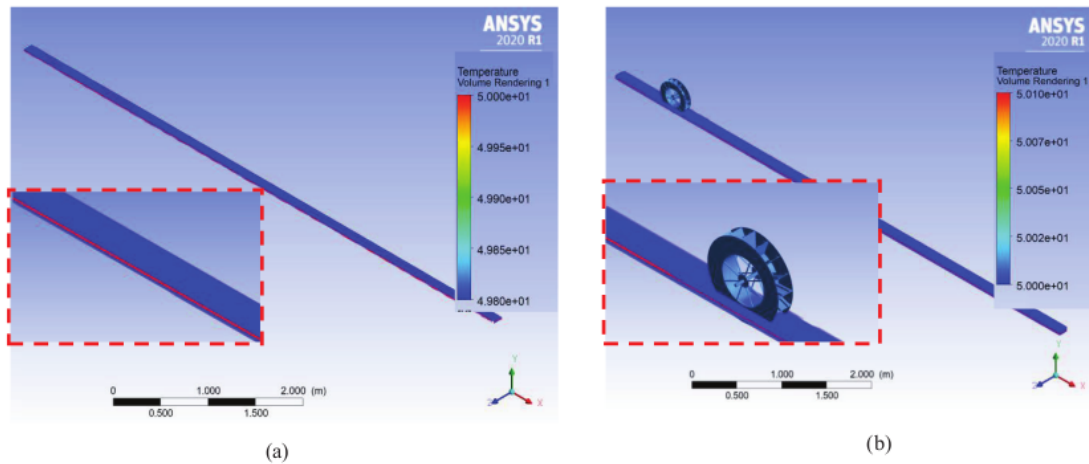

FIGURE 6. Temperature volume rendering of wastewater pit (a) No water wheel and (b) With two fins longitudinal parallel

CONCLUSIONS

Experimental and numerical simulations were carried out for flow through wastewater pit with various water wheel types compared wastewater pit without water wheel. The water wheel has a positive effect in reducing wastewater temperature compared to a channel that is not equipped with a water wheel (based on experimental results). The two fins transverse parallel water wheel shows the highest improvement of reducing wastewater temperature. The resulting decrease in the final temperature reached 5.564% (around 2.782^oC). The difference temperature drop that can be generated between two-fins transverse parallel water wheel and without water wheel is 4.844% (around 2.422^oC). The computational results obtained from the present studies are in good agreement with the experimental data for the case of a wastewater pit without a water wheel. However, for the other cases (wastewater pit attached with water wheel), the simulation results show a significant difference in temperature distribution at the midline axis along the axial positions compare with experimental data.

10

ACKNOWLEDGMENTS

The research leading to these results has received funding from State Polytechnic of Ujung Pandang (Politeknik Negeri Ujung Pandang), Indonesia.

REFERENCES

1. A. Hasan, J. Teknol. Lingkungan. **7**, (2006). [in Bahasa]
2. C. Anam, Study of Cooling Water Heat Distribution Pattern at PT. Pembangunan Jawa-Bali Gresik Power Unit (PT. PJB UP Gresik), Institut Teknologi Sepuluh Nopember, 2015. [in Bahasa]
3. A.R. Leffler, R.C. Bradshaw, A.E. Groll, and V.S. Garimella, *Appl. Energy* **92**, 17 (2012).
4. A.H. Frediani, *Cooling Canal System Modeling Report* (Golder Associates Inc, Atlanta, 2008).
5. W.I. Nurjaya and H. Surbakti, J. Ilmu Dan Teknol. Kelaut. Trop. **2**, (2010).
6. B. Ulum, Modeling of Water Quality in Jenepono Waters Study/Case of Cooling Water Distribution of PLTU Jenepono Punagaya Village Bangkala Districts Jenepono, Hasanuddin University, 2017. [in Bahasa]
7. Y.M. Yunus and Firman, in *Semin. Nas. Has. Penelit. Pengabd. Kpd. Masy.* (2019), p. 107. [in Bahasa]
8. S. Sahlan and A. Razak, J. Powerpl. **1**, 61 (2013). [in Bahasa]
9. Y. Klistafani, I.M. Klistafani, and G. Bangga, J. Fundam. Appl. Eng. Mech. **38**, 256 (2018).
10. Y.Q. Yang, H.T. Liu, Z.W. Lu, and K.X. Wang, *Adv. Mech. Eng.* **5**, 860431 (2013).
11. Y. Klistafani, J. INTEK **5**, 22 (2018). [in Bahasa]
12. Y. Klistafani, *INTEK J. Penelit.* **4**, 20 (2017). [in Bahasa]

Assessment of various water wheel types to improve wastewater pit performance

ORIGINALITY REPORT

21%

SIMILARITY INDEX

PRIMARY SOURCES

- | | | |
|---|--|----------------|
| 1 | journals.ub.uni-magdeburg.de
Internet | 265 words — 9% |
| 2 | docs.lib.purdue.edu
Internet | 95 words — 3% |
| 3 | journals.sagepub.com
Internet | 57 words — 2% |
| 4 | Ikhsan Mahardhika Utama, Fifi Hesty, Rif'ah Amalia, Setyo Nugroho. "Analysis The Effect of Inlet Duct and Transition Zone Angle Variations on Flow Characteristics and Heat Transfer on Vertical Type Heat Recovery Steam Generator", 2021 International Electronics Symposium (IES), 2021
Crossref | 34 words — 1% |
| 5 | rep.vstu.by
Internet | 33 words — 1% |
| 6 | Robert A. Leffler, Craig R. Bradshaw, Eckhard A. Groll, Suresh V. Garimella. "Alternative heat rejection methods for power plants", Applied Energy, 2012
Crossref | 32 words — 1% |
| 7 | Mimi Arifin, Shirly Wunas, Pratiwi Mushar. "Characteristics of the settlement and coastal | 27 words — 1% |

disasters threat on the economic development conditions of Lero local residents", AIP Publishing, 2022

Crossref

8 Nida Nabilah, Imam Mukhlash, Erma Suryani. "System dynamics implementation to analyze electricity demand and capacity planning in East Java", AIP Publishing, 2023 20 words — 1%

Crossref

9 Muhammad Arsyad Suyuti, Muhammad Iswar, Rusdi Nur. "Effect of punch angle and punch radius on bend angle through air V-bending of sheet metal", AIP Publishing, 2019 19 words — 1%

Crossref

10 Y Klistafani, M I Mukhsen. "Development of a Shrouded Wind Turbine with Various Diffuser Type Structures", IOP Conference Series: Materials Science and Engineering, 2019 12 words — < 1%

Crossref

11 p-prof.kmutt.ac.th 9 words — < 1%

Internet

EXCLUDE QUOTES OFF

EXCLUDE SOURCES OFF

EXCLUDE BIBLIOGRAPHY ON

EXCLUDE MATCHES OFF