

Application of Energy Storage-PID For Load Frequency Control In Micro-hydro Using Flower Pollination Algorithm

Machrus Ali

Department of Electrical Engineering
Universitas Darul Ulum
Jombang, Indonesia
machrus7@gmail.com

Muhlasin

Department of Electrical Engineering
Universitas Darul Ulum
Jombang, Indonesia
doktermuhlasin@gmail.com

Muhammad Ruswandi Djalal

Department of Mechanical Engineering
State Polytechnic of Ujung Pandang
Makassar, Indonesia
wandi@poliupg.ac.id

Muhammad Fakhrurozi

Department of Mechanical Engineering
Universitas Darul Ulum
Jombang, Indonesia
rozilibra65@gmail.com

Saiful Arfaah

Department of Civil Engineering
Universitas Darul Ulum
Jombang, Indonesia
saiful.arfaah@gmail.com

Ruslan Hidayat

Department of Civil Engineering
Universitas Darul Ulum
Jombang, Indonesia
Ruslanh.1964@gmail.com

Abstract—To get optimal SMES and CES performance, optimal parameter tuning is needed. This research uses an artificial intelligence method based on the Flower Pollination Algorithm (FPA) for the optimization of SMES and CES parameters. The FPA algorithm performs computations based on objective functions, namely optimizing Integral Time Absolute Error (ITAE). To test the reliability of micro-hydro, a disturbance is given in the form of load changes, then analyzed the governor response and micro-hydro frequency. In addition, in this study, a combination of SMES and CES control system scenarios with conventional PID controllers was used. From the results of the correct tuning of the SMES and CES parameters, the optimal micro-hydro performance was obtained. This is shown by the overshoot governor response and the minimum frequency and faster settling time using the methods proposed by SMES and CES.

Keywords: Micro-Hydro, Superconducting Magnetic-Capacitive Energy Storage, Flower Pollination Algorithm, Overshoot

I. INTRODUCTION

The stability of the micro-hydro power plant is a major concern in its operation because, at steady-state operating conditions, the average speed for all generators must be the same or synchronous. The rotational speed of the generator on the micro-hydro will affect the frequency and voltage generated. The rotational speed of the generator is affected by changes in the load. At night at 23.00, the load usage will decrease. This will certainly affect the performance of the micro-hydro.

Because of this, the motion wheel rotates faster. As a result, the frequency of electricity increases and if it is too high, it endangers the consumer's electrical equipment. Therefore, to support the performance of micro-hydro, frequency regulation is needed, so that it is always in the work area between 49 Hz - 51 Hz. The control mechanism is carried out automatically, by adjusting the position of the gate opening, so that the incoming water flow can be adjusted to the load. Therefore, a technology is needed to optimize the performance of the micro-hydro unit, by applying Load Frequency Control.

Load Frequency Control in this study was designed using Superconducting Magnetic Energy Storage (SMES) and Capacitive Energy Storage (CES). SMES and CES are devices that can provide power compensation, thereby reducing frequency oscillations caused by load changes. SMES and CES provide energy storage and release systems that operate quickly and automatically. To get good damping, it is necessary to tune the SMES and CES parameters optimally, so that they can be used properly in the system. In this study, the Flower Pollination Algorithm (FPA) method is proposed to optimize the SMES and CES parameters. The implementation of SMES and CES system frequency controllers produces optimal performance, such as [1-4] which discusses the application of SMES in wind turbines and produces reliable wind turbines. [5] discusses the application of SMES in multi-machine systems and produces an optimal system. [6] discussed the application of CES to micro-hydro to produce optimal micro-hydro performance. [7] discussed the application of SMES and CES to micro-hydro based on Cuckoo Search to obtain optimal frequency settings for micro-hydro. In this study, the optimization results using the Cuckoo Search method can still be improved with other algorithms.

The Flower Pollination Algorithm is one of the algorithms introduced by Xin-She Yang in 2012 [8]. This algorithm is inspired by the pollination process in flowering plants. The application of the FPA method to the electric power system shows optimal results, such as [9] discussing the scheduling of thermal generators using FPA to produce optimal scheduling. [10, 11] discussed PID controller optimization to produce optimal PID parameters. [12] discussed the optimization of frequency load control in thermal generators. [13] discussed the optimization of maximum power point tracking solar cells using FPA to produce optimal solar cell performance. [14] discussed the optimization of the placement of the Phasor Measurement Unit (PMU) using the FPA to produce an optimal placement of the PMU. These studies shows that the application of FPA in the electric

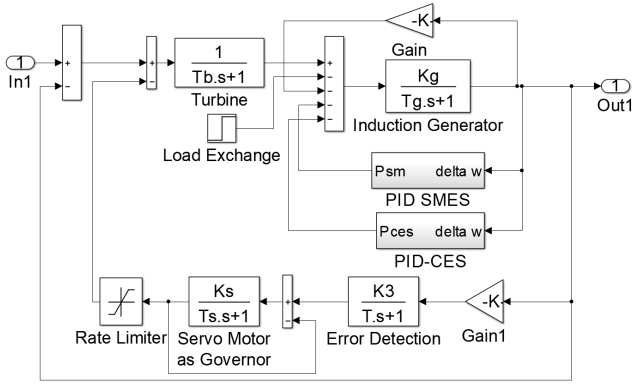

Fig.1. Simulink model of the entire system.

the power system is very suitable to produce a reliable and optimal system.

In this research, load frequency control mechanism is designed using Superconducting Magnetic Energy Storage (SMES) and Capacitive Energy Storage (CES), which can provide power compensation to reduce or even eliminate

frequency oscillations caused by changes in the electrical power load of customers. SMES and CES parameters are optimized using an intelligent algorithm based on Flower Pollination Algorithm. With accurate SMES and CES parameters, optimal performance is obtained when load changes occur.

II. RESEARCH METHODS

This section provides a dynamic model of the overall system, and flower pollination algorithm. At the end of this section, the objective function of the simulation is presented and the objective function will be achieved by using FPA.

A. Overall Simulation

The dynamic model of the entire system can be expressed in Fig 1. The mathematical representation of electric power that can be generated from micro-hydro can be described as given in (1).

$$P_{th}[W] = Q[m^3/s]. H[m]. k[N/kg] \quad (1)$$

Where P_{th} and Q are active power generated from micro-hydro and the amount of water flow to the turbine. H is the height of the water flow and k is the gravitational constant. Moreover, completed representation of active power from the systems considering turbine ($\eta_{turbine}$) and generator (η_{gen}) efficiency can be described using (2).

$$P_{real}[W] = Q[m^3/s]. H[m]. k[N/kg]. \eta_{turbine}. \eta_{gen} \quad (2)$$

For frequency stability study, the micro-hydro power plant modeled as a linear system, consisting of induction generator, turbine, and servomotor as the governor as illustrated in Fig. 1

Fig 2 illustrates the test system with SMES installed in the system. SMES start from the input side in the form of $\Delta\omega$. After that, the signal will enter the washout block where there is a time washout constant from SMES. It is then amplified by the SMES reinforcing constant on the loop gain block. In this block, there is also a T_{dc} time delay constant from the

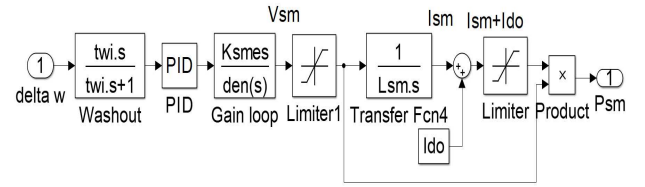

Fig.2. Simulink model of SMES.

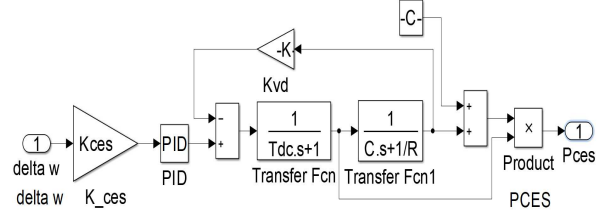

Fig.3. Simulink model of CES

TABLE I. ANALYSIS FF INTEREST ALGORITHM WITH OPTIMIZATION [15, 16]

Optimization Problems:	
max or min $f(x_i), x_i = (x_1, x_2, \dots, x_n) \in S^d \subset R^d, i = 1, 2, \dots, n$	
Pollination Phenomenon	Optimization Problems
Areas of Pollination Coverage	Value interval $S^d, x \in S^d$
Population of Interest	Solution Candidate (x_1, x_2, \dots, x_n)
Interest rate match rate	Objective Function f
The event of pollination effort	Iteration
Flower Pollination Motion	Solution Search on Regional Definitions
Selected Individuals that match	Optimum State

SMES control device. Then go to the rate limiter to restrict the signal to the desired saturation conditions. The next signal is forwarded to the inductance SMES block where there is parameter L_{sm} . From the output of I_{sm} is summed with I_{do} to product output. So the resulting output P_{sm} is used as input (compensation) on the generator while waiting for the governor's work. Figure 3 is the CES model used. The working principle of CES is that it can store energy in the capacitor in the form of an electric field. The CES part is the storage capacitor and the Power Conversion System. The storage capacitor consists of discrete capacitors. These capacitors are connected in parallel, with a capacitance (C). Leaking losses and dielectric capacitor bank connected in parallel to the capacitor. Storage capacitor connects to the grid through the Power Conversion System (PCS) 12-pulse. PCS consists of ac to dc rectifier and dc to ac inverter.

In this research, all of the systems are expressed in the linear model. The parameter that will be optimized by FPA is the SMES and CES parameter.

B. Flower Pollination Algorithm

Flower Pollination Algorithm is one of the optimization algorithms that can be used for decision making [8]. This algorithm imitates the behavior of pollinating flowers by insects in the universe. Insects will move from flower to flower to help pollinate flowers. Of course, a flower that looks better will be chosen by an insect to crawl over a flower that looks less good. The flower constancy phenomenon can be represented mathematically as follows.

$$x_i^{l+1} = x_i^l + \gamma L(\lambda) (x_i^l - g^*) \quad (3)$$

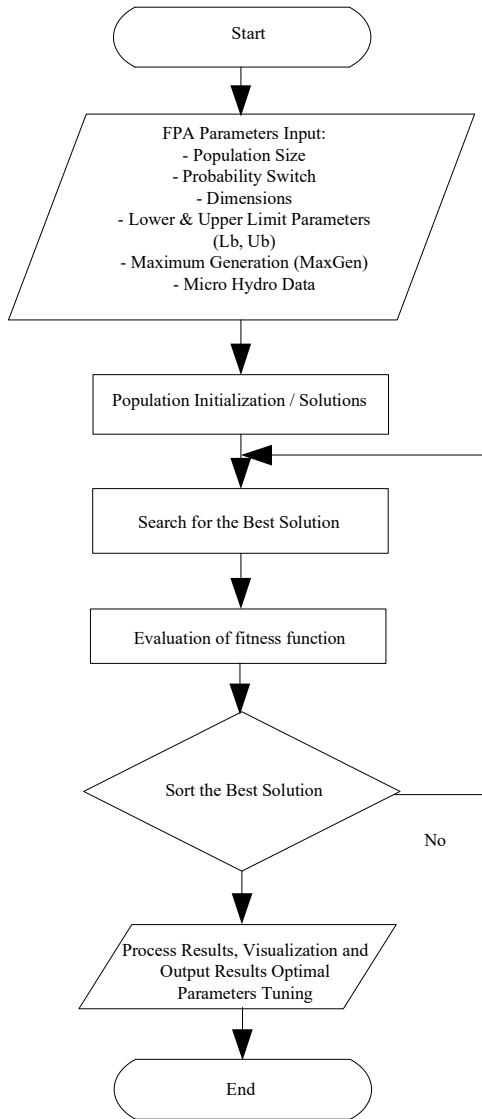

Fig.4. Research Flowchart

a. *mObjective Function*

The objective function that is used is Integral Time Absolute Error (ITAE), where the FPA will be optimized all parameters by minimizing the frequency error of the micro-hydro as described in (2).

$$ITAE = \int_0^t t|\Delta\omega(t)|dt \quad (4)$$

Where $\Delta\omega$ is the frequency deviation of the system, while t is the period of the simulation. Fig 4 shows the flowchart of the FPA for optimizing SMES and CES parameters. The parameter of SMES that will be optimized by FPA is K_{smes} , T_{dc} , T_w , K_p , K_i , and K_d , while the parameter of CES is K_{ces} , T_{dc} , K_p , K_i , and K_d . Table 3 shows the parameter of the flower pollination algorithm, while Table 4 shows the lower and upper limits of the SMES and CES parameters.

III. RESULTS AND DISCUSSION

This research discusses three system analyses, namely analysis of governor response, turbine response, and micro-hydro frequency response. The system is modeled using Matlab / Simulink software. To test the system performance

TABLE II. PARAMETERS OF FLOWER POLLINATION ALGORITHM.

Parameter	Value
Population Size	20
Probability Switch	0.8
Dimension	11
Max Generation	50
Number of Variable (nd)	11

TABLE III. CONSTRAINT

Parameters	Lower	Upper
CES		
K_{ces}	80	90
T_{dc}	0.03	0.06
K_p	10	15
K_i	0.1	0.5
K_d	0	1
SMES		
T_{dc}	0.01	0.03
T_w	15	30
K_{SMES}	70	90
K_p	35	40
K_i	0	1
K_d	0	0.1

TABLE IV. DYNAMIC DATA OF THE TEST SYSTEM [17].

Parameter	Value
T_b	1
K_g	1
T_g	13,333
K_1	5
K_2	8,52
K_3	0.004
T	0,02
T_s	0,1
K_s	2,5
S_g	40
P_f	0,8
V_g	400/231
ω	1500
f_g	50

TABLE V. OPTIMAL PARAMETER OF SMES AND CES

Parameters	FPA Result	Parameters	FPA Result
CES		SMES	
K_{ces}	88.0117	T_{dc}	0.0179
T_{dc}	0.0500	T_w	19.4975
K_p	10.0504	K_{SMES}	81
K_i	0.4055	K_p	39.1982
K_d	0.6522	K_i	0.9308
		K_d	0.0159

the improvement according to the proposed method, this research uses several micro-hydro control system designs. Table 5 below shows the dynamic data of the micro-hydro system. Table 6 shows the SMES and CES data-optimized using the flower pollination algorithm method.

a. *Governor time-domain response*

In this section, the micro-hydro governor response is analyzed with interference in the form of load changes. Figure 5 shows the governor's response to several micro-hydro control system scenarios. From this graph, it is obtained several characteristics of micro-hydro governor response. By using a control system based on SMES-PID-CES-PID with the FPA optimization method, a minimum overshoot of the governor response is obtained.

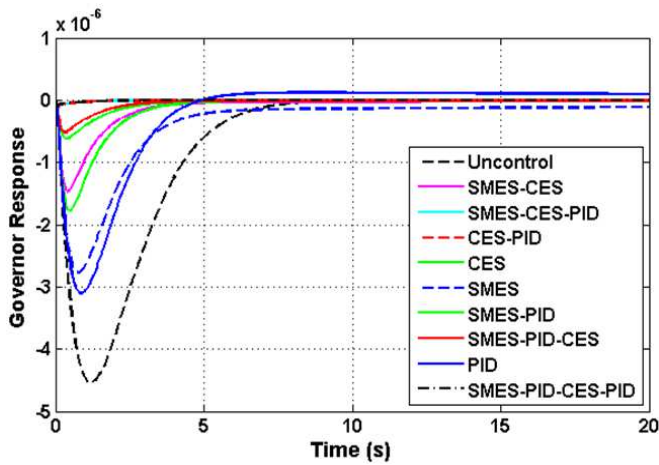

Fig.5. Respon Governor Micro-hydro

TABLE VI. OVERSHOOT OF GOVERNOR

Cases	Overshoot
Uncontrolled	-4.541e-06
PID	-1.467e-06
CES	-1.291e-07
CES-PID	-1.311e-07
SMES	-1.778e-06
SMES-PID	-2.771e-06
SMES-CES	-6.2e-07
SMES-CES-PID	-5.196e-07
SMES-PID-CES	-3.102e-06
SMES-PID-CES-PID	-9.218e-08

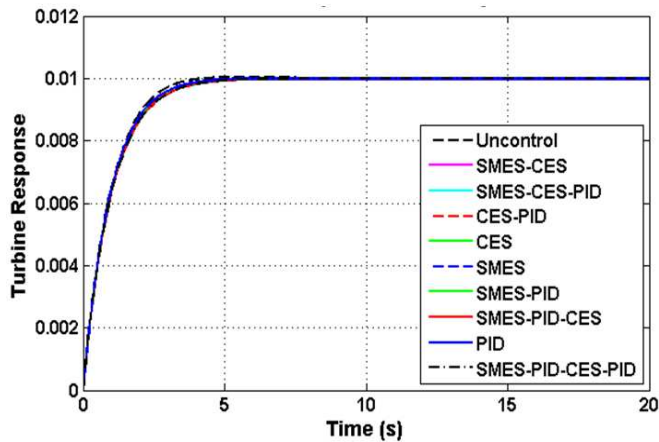

Fig.6. Turbine response under different scenarios.

Table 7 shows the overshoot of several micro-hydro control system scenarios. From the analysis results obtained an optimal overshoot response using the SMES-PID-CES-PID. This is indicated by the minimum overshoot and faster settling time, compared to other control scenarios.

The increase in the performance of the micro-hydro system can be seen from the response of the micro-hydro system governor, as shown in Figure 5. With the optimal performance of the governor using the proposed method, the micro-hydro turbine response will be more optimal. This is indicated by the faster turbine response when there is a load change, this can be seen in Figure 6. Where using the SMES-PID-CES-PID control scenario results in a faster settling time than other control scenarios.

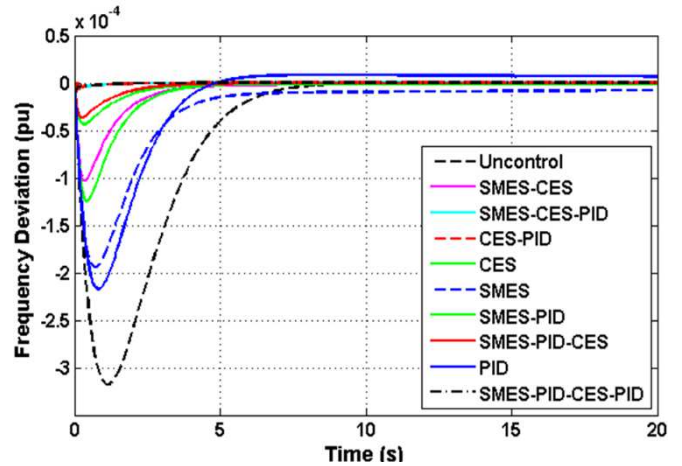

Fig.7. Frequency response under different scenarios

TABLE VII. OVERSHOOT OF FREQUENCY

Cases	Overshoot
Uncontrolled	-0.000318
PID	-0.0001033
CES	-1.453e-05
CES-PID	-1.463e-05
SMES	-0.0001249
SMES-PID	-0.0001943
SMES-CES	-4.358e-05
SMES-CES-PID	-3.663e-05
SMES-PID-CES	-0.0002173
SMES-PID-CES-PID	-9.649e-06

b. Frequency dynamic response

The next analysis is the frequency response of micro-hydro. By providing interference in the form of load changes, then reviewing the micro-hydro frequency response. Figure 7 shows a comparison of the frequency response for several types of micro-hydro control systems. From the analysis results, using the SMES-PID-CES-PID control method, the optimal micro-hydro frequency performance was obtained. This is due to the addition of active power from SMES and CES.

Table 8 shows the overshoot response of each controller. From the table, it is found that systems with SMES-PID and CES-PID produce lower overshoot compared to other control system scenarios. Moreover, SMES and CES could store and release active power from the system depending on the condition of the load. If the load was increased then SMES and CES will release (discharging) active power to the system so the burden of the system is decreased (the system will experience lower overshoot). In contrast, if the load was decreased the SMES and CES will store (charging) surplus active power from the system.

IV. CONCLUSION

This study proposes a method of increasing the frequency of the micro-hydro system using a hybrid SMES and CES based on the Flower Pollination Algorithm. From the analysis results obtained, the addition of SMES and CES controls can improve the performance of the micro-hydro frequency when a load changes. This is indicated by the minimum overshoot and faster settling time than other control schemes. The application of the Flower Pollination Algorithm method as an optimization method for SMES and CES parameters can improve system performance. With optimal tuning, it results in increased micro-hydro performance.

The implementation of energy storage technology and intelligent optimization can improve the performance of the power system, for further research, Battery Energy Storage (BES) technology can be implemented and combined with SMES and CES.

REFERENCES

- [1] A. M. S. Yunus and M. Saini, "Overview of SMES units application on smart grid systems," in *2016 International Seminar on Intelligent Technology and Its Applications (ISITIA)*, 2016, pp. 465-470.
- [2] A. S. Yunus, A. Abu-Siada, and M. Masoum, "Effect of SMES unit on the performance of type 4 wind turbine generator during voltage sag," 2011.
- [3] A. S. Yunus, A. Abu-Siada, and M. Masoum, "Effects of SMES on dynamic behaviors of type D-Wind Turbine Generator-Grid connected during short circuit," in *Power and Energy Society General Meeting, 2011 IEEE*, 2011, pp. 1-6: IEEE.
- [4] A. S. Yunus and M. Saini, "Overview of SMES units application on smart grid systems," in *2016 International Seminar on Intelligent Technology and Its Applications (ISITIA)*, 2016, pp. 465-470: IEEE.
- [5] D. Lastomo, H. Setiadi, and M. R. Djalal, "Optimization of SMES and TCSC using particle swarm optimization for oscillation mitigation in a multi machines power system," *Journal of Mechatronics, Electrical Power, and Vehicular Technology*, vol. 8, no. 1, pp. 11-21.
- [6] M. R. Djalal, M. Yunus, A. Imran, and H. Setiadi, "Capacitive energy storage (CES) optimization for load frequency control in micro-hydro power plant using imperialist competitive algorithm (ICA)," *EMITTER International Journal of Engineering Technology*, vol. 5, no. 2, pp. 279-297, 2017.
- [7] M. R. Djalal, H. Setiadi, and A. Imran, "Frequency stability improvement of micro-hydro power system using hybrid SMES and CES based on Cuckoo search algorithm," *Journal of Mechatronics, Electrical Power, and Vehicular Technology*, vol. 8, no. 2, pp. 76-84.
- [8] X.-S. Yang, "Flower pollination algorithm for global optimization," in *International conference on unconventional computing and natural computation*, 2012, pp. 240-249: Springer.
- [9] T. Balachander, P. A. Jeyanthi, and D. Devaraj, "Short term hydro thermal scheduling using flower pollination algorithm," in *Intelligent Techniques in Control, Optimization and Signal Processing (INCOS), 2017 IEEE International Conference*, 2017, pp. 1-5: IEEE.
- [10] I. Hussain, S. Ranjan, D. C. Das, and N. Sinha, "Performance Analysis of Flower Pollination Algorithm Optimized PID Controller for Wind-PV-SMES-BESS-Diesel Autonomous Hybrid Power System," *International Journal of Renewable Energy Research (IJRER)*, vol. 7, no. 2, pp. 643-651, 2017.
- [11] D. Lastomo, M. Djalal, and I. R. Widodo, "Optimization of PID controller design for DC motor based on flower pollination algorithm," in *The 2015 International Conference on Electrical, Telecommunication and Computer Engineering (ELTICOM 2015)*, 2015.
- [12] D. Lakshmi, A. P. Fathima, and R. Muthu, "A novel flower pollination algorithm to solve load frequency control for a hydro-thermal deregulated power system," 2016.
- [13] J. P. Ram and N. Rajasekar, "A novel flower pollination based global maximum power point method for solar maximum power point tracking," *IEEE Transactions on Power Electronics*, vol. 32, no. 11, pp. 8486-8499, 2017.
- [14] K. M. Hassanin, A. A. Abdelsalam, and A. Y. Abdelaziz, "Optimal PMUs Placement for Full Observability of Electrical Power Systems Using Flower Pollination Algorithm."
- [15] D. Lastomo, "Simulasi Pengendali Sudut Pitch Blade Pada Turbin Angin Dengan Flower Pollination Algorithm (FPA) Untuk Mengoptimalkan Konversi Daya Listrik," *Master Thesis ITS*, 2016.
- [16] D. Lastomo, H. Setiadi, and M. R. Djalal, "Enabling PID and SSSC for load frequency control using Particle Swarm Optimization," in *Science in Information Technology (ICSITech), 2017 3rd International Conference on*, 2017, pp. 182-187: IEEE.
- [17] I. T. Yuniahastuti, I. Anshori, and I. Robandi, "Load frequency control (LFC) of micro-hydropower plant with Capacitive Energy Storage (CES) using Bat Algorithm (BA)," in *Technology of Information and Communication (ISEmantic), International Seminar on Application for*, 2016, pp. 147-151: IEEE.