

Ground Fault Currents in Unit Generator Transformer at Various Voltage and Transformer Configurations

By Ahmad Rizal Sultan



Ground Fault Currents in Unit Generator Transformer at Various Voltage and Transformer Configurations

KEYWORDS

ground fault currents, neutral grounding, transformer configurations

Ahmad Rizal Sultan

Research Scholar, Faculty of Electrical Engineering
UTM, Malaysia 81300

Mohd Wazir Mustafa

Professor, Faculty of Electrical Engineering UTM.,
Malaysia 81300

ABSTRACT Single line to ground fault (SLGF) is the most frequent fault probable to occur in an electric power system. The effect of ground fault is determined by voltage transformer and transformer configurations. In this paper, the simulation showed the performance generator within the SLGF at various transformer configurations. Simulation was conducted in DigSILENT PowerFactory 14.0. and the results were analyzed, presenting comparison of the fault impact at various transformer connections. The model of transformer connection for each side (primary and secondary) used were Y, Yn, Z, Zn and Δ . The Y, Z and Δ secondary side of transformer configuration were utilized to block the single line to ground fault at the generator bus. It was clearly shown that the SLGF at the generator bus was highly dependent upon the type of the transformer configurations used during the ground fault at the secondary side of transformer.

INTRODUCTION

In general, a step up transformer in electric power station can be categorized as unit generator-transformer configuration, unit generator-transformer configuration with generator breaker, cross-compound generator and generator involving a unit transformer [1]. Ground fault at the transmission line or busbar can affect the system configuration of the generator. Knowledge of ground fault at transformer winding connections is essential to choose an appropriate transformer for service requirement. Research and applications on transformers have been carried out for decades. IEEE std. C57.12.70-2000 [2] provides guides and recommended practices for terminal marking and connections for distribution and power transformers. IEEE std. C57.116-1989 [3] provides guides for direct connection of transformers to generators, while IEEE std. 519-1992 [4] and IEEE std. 142-2007 [5] address the harmonics and system grounding related to transformers, respectively.

The transformer configurations with the propagation of voltage sags [6] can influence the performance of voltage sags inside the industry facility, depending on the function of transformer configurations used in the service transformer. [7] describes the effect of the voltage transformers on the operating conditions of a ground-fault protection system for unit-connected generators. The magnitude of ground fault current, especially at the generator and transformer are determined by the generator and transformer winding impedance [1],[8]. The protection for generators are influenced by the arrangement and selection of how the generators are united into the system and by the overall generating station arrangement.

This paper presents the effect of transformer connection, which were denoted as wye (Y), wye-grounded (Yn), zigzag (Z), zigzag grounded (Zn) and delta (Δ) in each side primary and secondary for unit generator-transformer configuration.

TRANSFORMER CONFIGURATION

The primary and secondary winding of the transformer can be connected in combinations of Y, Yn, Z, Zn or Δ configurations, which can result in twenty five possible connection combinations [9]. Y-Y, Y-Yn, Y-Z, Y-Zn, Y- Δ , Yn-Yn, Yn-Y, Yn-Z, Yn-Zn, Yn- Δ , Z-Y, Z-Yn, Z-Z, Z-Zn, Z- Δ , Zn-Y, Zn-Yn, Zn-Z, Zn-Zn, Zn- Δ , Δ -Y, Δ -Yn, Δ -Z, Δ -Zn and Δ - Δ . The simple schematics for Yn-Yn and Δ -Yn configurations are shown in Figure 1. The zero-sequence impedance into a transformer depends on the configuration of the winding. The zero-sequence impedance of a Δ winding is infinite, whereas the zero-sequence

impedance of a Y-connected winding is a composite series of the zero-sequence impedance of the transformer and the impedance of any neutral grounding devices that might be present. Thus, an ungrounded Y-winding would present infinite zero-sequence impedance because the absence of a neutral grounding connection appears as an open circuit in series with the zero-sequence impedance of the transformer winding itself [11].

The impedance of the transformer itself depends on several factors in the construction of the transformer. Three-phase transformers, which are constructed so that a closed, low-impedance path exists for the flow of zero-sequence flux within the transformer, have a lower zero sequence impedance than the transformers without such a path. One such path is the transformer core. Transformers with core-form construction have lower zero-sequence impedances than units which have shell-form cores. Three-phase transformers with Δ windings have the lowest zero-sequence impedance, and in the absence of actual test data, it is often assumed that the zero-sequence impedance of core-form transformers with Δ winding is about 0.85 times having positive-sequence leakage reactance of such transformers [11]. The zero-sequence impedance of shell-form transformers has about the same magnitude as the positive-sequence leakage reactance of such transformers. Conversely, a three-phase transformer-bank, consisting of three, single-phase transformers connected in Y-Y configuration, has a very high zero-sequence impedance [9].

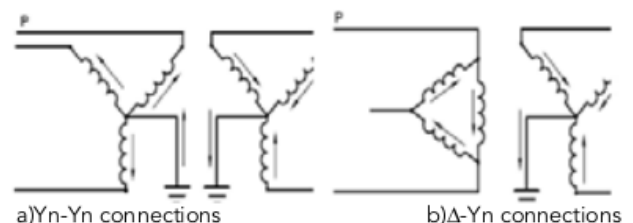

Figure 1. Connection's diagram of Yn-Yn and D-Yn transformer [9]

Zero-sequence components of current can flow through a Yn-Yn connected transformer if a neutral path exists on both sides of the transformer. An example is shown in Figure 2, where a Δ -Yn connected transformer (T1), supplies power to a Yn-Yn connected transformer (T2). A fault on the load side of T2 produces a zero-sequence current, which flows in the primary and secondary windings of that transformer. Zero-

sequence current is permitted to flow through the primary of T2 because a path exists in the Δ -Yn connected transformer T1. Disconnecting any of transformer neutrals, on either T1 or T2, would prevent the flow of zero-sequence current in both transformers, except if allowed by magnetizing reactance. Depending upon the connections to the transformer, the use of a Yn-Yn transformer can result in a single system, or its load side may be a separately derived system.

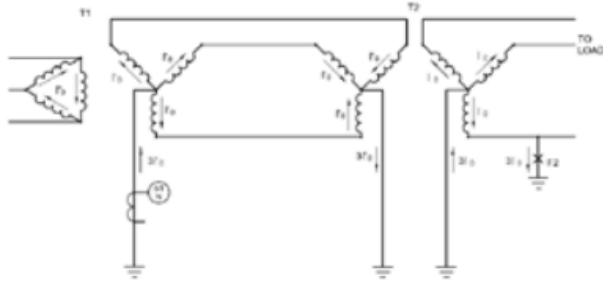

Figure 2. Transformer connections illustrating the flow of zero-sequence current resulting from a line to ground fault [5]

The Y-Y connections offer advantages of decreased insulation cost and availability of the neutral terminal for grounding purposes. However, because of a problem associated with third harmonic and unbalanced operation, this connection is rarely used [9]. Y- Δ or Δ -Y transformers are the most commonly used connections in assembling a transformer. This connection is more stable with respect to unbalanced loads, and if the Y-connections are used on the high-voltage side, the insulation costs can be reduced. The Y- Δ connection is commonly used to step down a high voltage to a lower voltage. The neutral point on the high-voltage side can be grounded. The Δ -Y connection is commonly used for stepping up to be high-voltage [5]. The Δ - Δ provides no neutral connection, and each transformer must withstand full line to line voltage. The Δ connections do, however, provide a path for third harmonic currents to flow [9].

In a Δ -Y connected transformer, with the load-side neutral grounded, zero-sequence components of current may flow in the secondary Y-connected windings due to a ground fault. The zero-sequence current will then be inducted into the primary windings on the transformer, to circulate in the Δ connection. Positive and negative-sequence currents will pass through the transformer, combining to produce high current in the two of the primary phase conductors. A ground fault on the secondary of the Δ -Y connected transformer appears as a line-to-line fault in the primary.

GROUND FAULT CURRENT

The majority of electric faults involve transference into ground. Even faults which are initiated phase to phase spread quickly to any adjacent metallic housing, conduit, or tray provide a return path to the system grounding point. Ungrounded systems are also subject to ground faults and require careful attention to ground detection and ground-fault protection.

The ground-fault protective sensitivity can be relatively independent of continuous load current values and, therefore, can have a lower pick up settings than phase protective devices. The ground-fault currents are not transferred through system power transformers that are connected in Δ -Y or Δ - Δ , as the ground-fault protection for each system voltage stage is independent of the protection at other voltage stages. This configuration permits much faster relaying than using phase-protective devices that require coordination using pickup values and time delays, which extend from the load to the source generators and often result in considerable time delay at some points in the system. Arcing ground faults that are

not promptly detected and cleared can be destructive.

An ungrounded system has no intended conjunction to be grounded except through potential indication, potential-measuring apparatus or through surge protective devices. A system is called ungrounded as it is coupled to the ground through the distributed capacitance of its phase windings and conductors. A grounded system is intentionally grounded by connecting its one conductor, commonly its neutral terminal, into the ground, either solidly or through current-limiting impedance. Various degrees of grounding, commonly resistance, are used ranging from solid to high impedance [9].

RESEARCH METHOD

This section presents the performance of various transformer connections at the generator bus during single line to ground fault (SLGF) in line bus, in the form of simulation model as illustrated in Figure 3. The following are the initial system parameters to the testing model:

- Generator-1(G1) = 247.5 MVA, 13.8 kV, Yn ; G2=192 MVA, 13.8 kV, Yn ; G3=128 MVA, 13.8 kV, Yn
- Transformer-1(T1) =250 MVA, 50 Hz, Yn-Yn, 13.8/230 kV
- Transformer-2(T2) =200 MVA, 50 Hz, Yn-Yn, 13.8/230 kV
- Transformer-3(T3) = 150 MVA, 50 Hz, Yn-Yn, 13.8/230 kV

Extensive simulation tests were carried out using DlgSILENT PowerFactory 14.0. The adjusted parameters were as follow:

- The type of transformer connection was changed. The type of transformer connection were Y, Yn, Z, Zn and Δ as primary and secondary transformer connections.
- The voltage transformer and type of transformer connection were changed
- Both the type of transformer and kinds of generator grounding were changed. The types of generator grounding were grounded (Yn), ungrounded (Y) or delta (Δ)

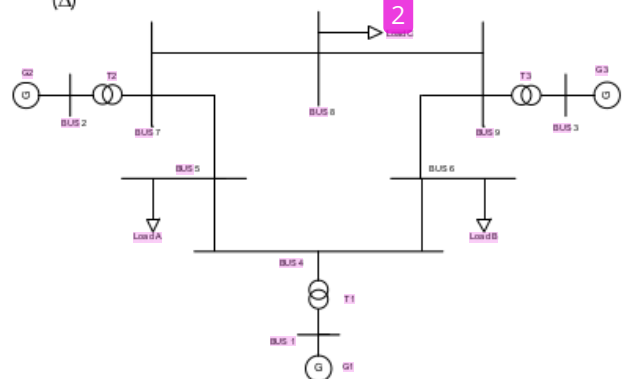

Figure 3. One-line diagram for analysis

ANALYSIS OF THE SIMULATION RESULTS

Figure 3 presents the analysis for the combination of Y, Yn, Z, Zn and Δ at both primary and secondary of the transformer. If SLGF occurred at bus or line system in the secondary side of transformer connection on Y, Z and Δ (Yn-Y, Yn-Z, Yn- Δ , Y-Y, Y-Z, Y- Δ , Zn-Y, Zn-Z, Zn- Δ , Z-Y, Z-Z, Z- Δ , Δ -Y, Δ -Z and Δ - Δ), it would result in no current / the zero sequence current flow.

The performance of fault location on the bus system for all generators is presented in Figure 4. The magnitudes of SLGF at a generator bus (G1, G2 and G3) for various transformer connections during ground fault at a secondary side of the transformer (T1, T2 and T3) are illustrated in Figure 5 – 7. The influences of grounding type of G1 on Yn-Yn, Y-Yn and Zn-Zn transformer connections for various buses as fault location are shown in Figure 8-10. The effects of the voltage level on SLGF current for various buses as fault location are shown in Figure 11-13.

As shown in Figure 4, the highest SLGF current occurred

when a ground fault was close to the generator bus. For G1, the highest ground fault currents at SLGF was at bus 4 (approximately 36.999 kA) following the other buses. In the same condition for G2, the highest SLGF current was at bus 7 (approximately 29.804 kA) and for G3, the ground fault current at SLGF was at bus 9 (roughly 22.501 kA). The effect or contributions of ground fault current for each generator to nearby the bus were influenced by the transformer configuration.

As demonstrated in Figure 5, the Yn-Yn transformer configuration had higher magnitude of GF than other transformer connections. In this condition, there was a route for zero-sequence current to flow in a primary and secondary of the transformer. The magnitude of SLGF currents was similar for Yn-Zn, Y-Zn, Zn-Zn, Z-Zn, Δ-Yn and Δ-Zn, which was 24.605 kA. The lowest SLGF from G1 to fault location of SLGF at bus 4 for Y-Yn, Zn-Yn and Z-Yn was 6.245 kA. The fault location of SLGF at bus 7 for G2 and fault location of SLGF at bus 9 for G3 followed the similarly condition, as shown in Figure 6-7.

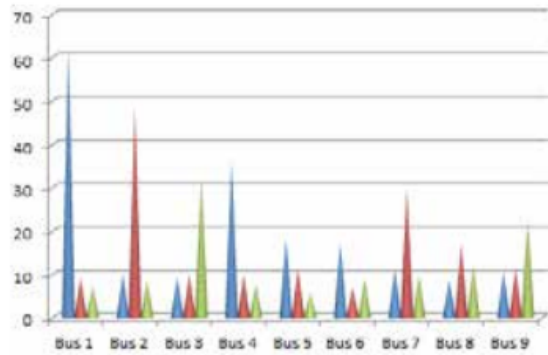

Figure 4. Magnitude of SLGF currents for various fault locations

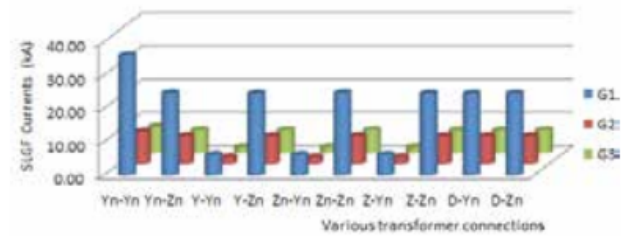

Figure 5. SLGF currents for various transformer connections during ground fault at bus 4

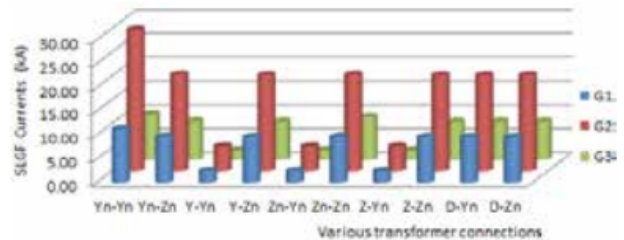

Figure 6. SLGF currents for various transformer connections during ground fault at bus 7

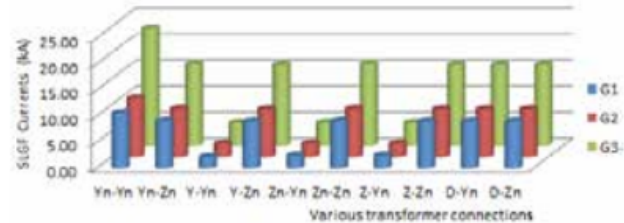

Figure 7. SLGF currents for various transformer connections during ground fault at bus 9

Figure 8 shows the effect grounding method of the generator-1 at Yn-Yn transformer connection (T1) for various fault locations. The magnitudes of SLGF current were dominant for Yn-grounding method of G1 than the Y or Δ-grounding methods. Both Y and Δ-grounding generator method results were same for ground fault at various buses. At Y-Yn transformer connection, the magnitude of SLGF current was greatest at bus 1, but was lower for other buses, especially for the Yn grounding method of the generator, as shown in Figure 9. Figure 10 indicates that for the other conditions for Zn-Zn transformer, the magnitudes of SLGF current were similar for various buses as fault location.

As shown in Figure 11, 12 and 13, even a small variation could influence the voltage level for SLGF currents for different fault locations at Yn-Yn, Y-Yn and Zn-Zn transformer connections. The magnitudes of SLGF current were influenced by fault location. Bus 1 and bus 4 resulted from the higher of ground fault currents than other buses, especially for Yn-Yn transformer connections. Ground fault at 11: primary side of the transformer (T1) resulted in a higher ground fault current than the secondary side of the transformer. The SLGF current was observed to flow from the G1 to the fault location.

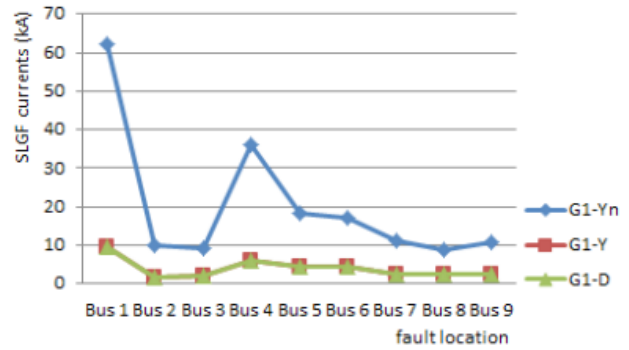

Figure 8. The influence of grounding type of Generator-1 for various buses as fault location at Yn-Yn transformer connection

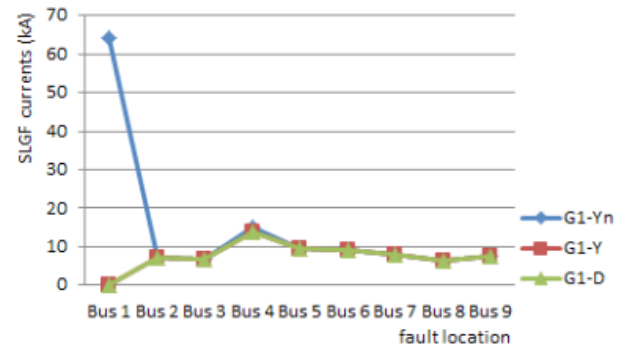

Figure 9. The influence of grounding type of Generator-1 for various buses as fault location at Y-Yn transformer connections

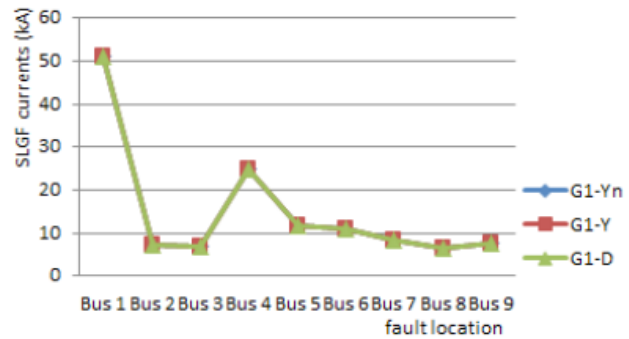

Figure 10. The influence of grounding type of Generator-1 for various buses as fault location at Zn-Zn transformer

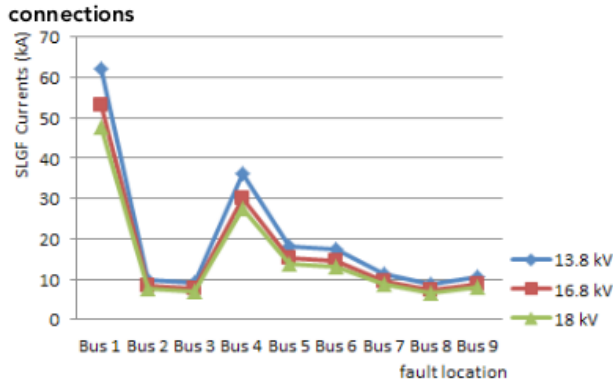

Figure. 11 . The influence of voltage level of Generator-1 for various buses as fault location at Yn-Yn transformer connection

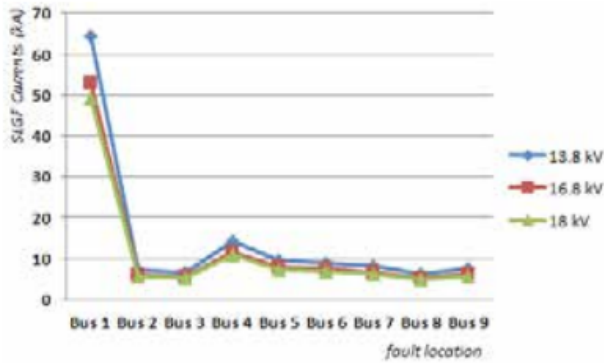

Figure.12 . The influence of voltage level of Generator-1

for various buses as fault location at Y-Yn transformer connection

CONCLUSIONS

This paper presents a simulation of the effect transformer connections on SLGF at the unit generator-transformer. It is clearly shown that the single line to ground fault is dependent on the kind of the transformer configuration used. From the study, the Y, Z and Δ secondary sides of transformer configuration were observed blocking the SLGF at bus of the generator.

From the finding, the Yn-Yn transformer connection had a higher magnitude ground fault at bus of a generator during SLGF at the secondary side of the transformer. It was also shown that the voltage level of the transformer and the generator grounding methods influenced the level of a SLGF at bus of the generator, especially for Yn-Yn transformer connections. The result indicated that the increase of the voltage level would decrease the ground fault current level.

REFERENCE

[1] (Institute of Electrical and Electronic Engineers [IEEE], 2006). IEEE Guide for AC Generator Protection, IEEE Std C37.102™. | [2] (Institute of Electrical and Electronic Engineers [IEEE], 2001). IEEE Standard for Standard Terminal Markings and Connections for Distribution and Power Transformers, IEEE std. C57.12.70. | [3] (Institute of Electrical and Electronic Engineers [IEEE], 1989). IEEE Guide for Transformer Directly Connected to Generators, IEEE Std C57.116. | [4] (Institute of Electrical and Electronic Engineers [IEEE], 1993). IEEE Recommended Practices and Requirements for Harmonic Control in Electric Power Systems, IEEE Std 519-1992. | [5] (Institute of Electrical and Electronic Engineers [IEEE], 2007). IEEE Recommended Practice for Grounding of Industrial and Commercial Power Systems, IEEE Std 142. | [6] M.T.Aung & J.V.Milanovic. (2006). The Influence of Transformer Winding Connections on the Propagation of Voltage Sags. IEEE Transaction on Power Delivery, Vol.21.No.1. | [7] Zielichowski M & Fulczyk M. (1998). Influence of voltage transformer on operating conditions of ground-fault protection system for unit-connected generator. Electrical Power & Energy Systems, vol. 20, pp. 313-319 | [8] Fulczyk.M & Bertsch.J. (2002). Ground-Fault Currents in Unit-Connected Generators With Different Elements Grounding Neutral. IEEE Transactions on Energy Conversion, Vol. 17, March 2002 | [9] Saadat H. (1999). Power System Analysis. McGraw-Hill. | [10] (Institute of Electrical and Electronic Engineers [IEEE], 2007). IEEE Recommended Practice for Grounding of Industrial and Commercial Power Systems, IEEE Std 142. ch.1 | [11] (Institute of Electrical and Electronic Engineers [IEEE], 2001). IEEE Recommended Practice for Protection and Coordination of Industrial and Commercial Power Systems, IEEE Std 242. ch.8. |

Ground Fault Currents in Unit Generator Transformer at Various Voltage and Transformer Configurations

ORIGINALITY REPORT

7%

SIMILARITY INDEX

PRIMARY SOURCES

- 1 Niya C P, Jayakumar T.V. "Analysis of different automatic cataract detection and classification methods", 2015 IEEE International Advance Computing Conference (IACC), 2015
Crossref 28 words — 1%
- 2 etd.lib.metu.edu.tr
Internet 23 words — 1%
- 3 M. Fulczyk, J. Bertsch. "Ground-fault currents in unit-connected generators with different elements grounding neutral", IEEE Transactions on Energy Conversion, 2002
Crossref 19 words — 1%
- 4 Devaprasad Paul, Arup Kumar Goswami, Subham Kumar, Sushant Jain, Adarsh Pandey. "Propagation of voltage sag considering different winding connections: Impact on the healthiness of Transformers", IEEE Transactions on Industry Applications, 2020
Crossref 16 words — 1%
- 5 Howard E. Bell. "ON THE COMMUTATIVITY OF PRIME RINGS WITH DERIVATION", Quaestiones Mathematicae, 1999
Crossref 16 words — 1%
- 6 ia802909.us.archive.org
Internet 16 words — 1%
- 7 Ali Ridha Al - Roomi. "Optimal Coordination of Power Protective Devices with Illustrative Examples", Wiley, 2021
Crossref 14 words — < 1%
- 8 J. Din. "Rain fading mitigation in BWA using Site Diversity", 2007 Asia-Pacific Conference on Applied Electromagnetics, 12/2007
Crossref 12 words — < 1%

-
- 9 Ghada M. Abo-Hamad, Doaa Khalil Ibrahim, Essam Aboul Zahab, Ahmed F. Zobaa. "Adaptive Mho Distance Protection for Interconnected Transmission Lines Compensated with Thyristor Controlled Series Capacitor", *Energies*, 2021
Crossref 10 words — < 1%
-
- 10 www.cnudst.rnrt.tn
Internet 10 words — < 1%
-
- 11 Platero, Carlos A., Francisco Blázquez, Pablo Frías, and Miguel Pardo. "New On-Line Rotor Ground Fault Location Method for Synchronous Machines With Static Excitation", *IEEE Transactions on Energy Conversion*, 2011.
Crossref 8 words — < 1%
-
- 12 Jimenez Toribio, Edy Ernesto. "Impact of Distributed Generation on unbalanced power systems", Proquest, 20111108
ProQuest 6 words — < 1%
-
- 13 Nur Iylia Shah Rimam, Mohd Faris Abdullah, Mohd Fakhizan Romlie, Zuhairi Baharudin. "The third harmonic generated voltage by salient-pole synchronous generator during 3-phase-to-ground fault", *International Transactions on Electrical Energy Systems*, 2017
Crossref 6 words — < 1%
-

EXCLUDE QUOTES OFF

EXCLUDE BIBLIOGRAPHY ON

EXCLUDE SOURCES OFF

EXCLUDE MATCHES OFF