

Ground Fault Currents in Unit Generator-Transformer at Various NGR and Transformer Configurations

By Ahmad Rizal Sultan

Ground Fault Currents in Unit Generator-Transformer at Various NGR and Transformer Configurations

A.R. Sultan, M.W. Mustafa, M.Saini
 Faculty of Electrical Engineering
 Universiti Teknologi Malaysia (UTM)
 Skudai, Johor Baharu, Malaysia
 Email : rizal.sultan@fkegraduate.utm.my

Abstract— Single line to ground faults are the most frequent faults likely to occur in the electric power system. The effect of ground fault is determined by generating station arrangements and transformer configurations. In this paper, the performance of the generator within the single line to ground fault at various Neutral Grounding Resistors (NGR) and transformer configurations is studied. Simulations were conducted in MATLAB/Simulink and the results are analyzed. A comparison with the impact of faults at various transformer connections is presented. The impact of faults for generator with NGR is also analyzed. On the unit generator-transformer, fault current in the generator neutral is greatest at Yg-Yg transformer connection followed by Yg-Y and Yg- Δ . In addition, for the transformer winding Y-Y, Y-Yg, Y- Δ , Δ -Y, Δ -Yg and Δ - Δ no current flows through the NGR of generator.

Keywords ; ground faults, neutral grounding resistor, transformer configurations

I. INTRODUCTION

In general, the transformer as a step up transformer in electric power station can be categorized as unit generator-transformer configuration, unit generator-transformer configuration with generator breaker, cross-compound generator and generator sharing a unit transformer [1]. Ground fault at transmission line or busbar can have effect on the generator are influenced by system configuration.

Generators are important components of power systems. Knowledge of ground fault at transformer winding connections is essential to choose an appropriate transformer for the given service requirement. Research and applications on transformers have been carried out for decades. IEEE std. 137.12.70-2000 [2] gives guides and recommended practices for terminal marking and connections for distribution and power transformers. IEEE std. C57.105-1978 [3] provides guides for transformer connections in three-phase distribution systems. IEEE std. 519-1992 [4] and IEEE std. 142-2007 [5] address harmonics and system grounding related to transformers, respectively [6].

The influences of transformer connection on operation are discussed [7] focus on operation included insulation stresses, autotransformer under various condition operations but not included for grounding. A resistance inserted between neutral and ground to limit the value of short-circuit current increases thereby the insulation stresses resulting from line grounds.

The unbalanced voltage will reduce if the Yg(wye grounded)-Yg transformer connected to the generator and the Δ (delta)-Yg transformer connected to load [8]. The winding

connection researcher usually recommended for industrial in-plan service is a Δ -Y(wye) at all voltage levels. There are reasoned for various types transformer winding connections to fulfill various needs such as to handle single-phase load, simplify ground relaying, save on initial investment by selecting a proper insulation system, minimize ferroresonance and avoid a harmonic problem[9].

The magnitude of ground fault current, especially at the generator and transformer are determined by generator and transformer winding impedance [1],[10]. The selection and arrangement of protection for generators are influenced to some degree by the method in which the generators are connected to the system and by the overall generating station arrangement. In this paper, the effect of transformer connection which is Y-Y, Y-Yg, Y- Δ , Yg-Y, Yg-Y, Yg- Δ , Δ -Y, Δ -Yg and Δ - Δ transformer to ground fault currents in NGR element for unit generator-transformer configuration, is presented. However, the ferroresonance, harmonic and arcing effects are neglected.

II. PRINCIPLE

A. Ground Faults Currents

The majority of electric faults involve ground. Even faults that are initiated a phase to phase spread quickly to any adjacent metallic housing, conduit, or tray that provides a return path to the system grounding point. Ungrounded systems are also subject to ground faults and require careful attention to ground detection and ground-fault protection. The ground-fault protective sensitivity can be relatively independent of continuous load current values and, therefore, have been lower pickup settings than phase protective devices. The ground-fault currents are not transferred through system power transformers that are connected Δ -Y or Δ - Δ , the ground-fault protection for each system voltage level is independent of the protection at other voltage levels. This configuration permits much faster relaying than can be afforded by phase-protective devices that require coordination using pickup values and time delays extend from the load to the source generators and often result in considerable time delay at some points in the system. Arcing ground faults that are not promptly detected and cleared can be destructive[11].

An ungrounded system has no intentional connection to be ground except through potential indicating or potential-measuring devices or through surge protective devices. While a system is called ungrounded, it is actually coupled to be ground through the distributed capacitance of its phase windings and conductors. A grounded system is intentionally grounded by connecting its neutral

or one conductor to be ground, either solidly or through a current-limiting impedance. Various degrees of grounding are used ranging from solid to high impedance, usually resistance.

Each type of grounding has advantages and disadvantages, and no one method is generally accepted. Factors that influence the choice to include voltage level of power system, transient overvoltage possibilities, type of equipment on the system, required continuity of service, caliber and training of operating and maintenance personnel, methods used on existing systems, availability of convenient grounding point, cost of equipment, safety and tolerable fault damage levels [5].

B. Neutral Grounding Resistors (NGR)

Grounding can be categorized into two general categories: solid grounding and impedance grounding. Impedance grounding may be further divided into several subcategories: reactance grounding, resistance grounding, and ground-fault neutralizer grounding [5]. For generator grounding, the grounding methods dominant are resistance grounding (39,4%), followed by solidly grounding(25,7%) then neutral reactor grounded (17,3 %) [12].

According to IEEE Std 142™-2007 [5], Resistance grounded is grounded through an impedance, the principal element of which is resistance. This grounding method can be divided into High-Resistance Grounded (HRG) and Low-Resistance Grounded (LRG). HRG is a resistance-grounded system designed to limit ground fault current to a value that can be allowed to flow for an extended period of time, while still meeting the criteria of $R0 < Xco$, so that transient voltages from arcing ground faults are reduced. The ground-fault current is usually limited to less than 10 A, resulting in limited damage even during prolonged faults. Then LRG is a resistance-grounded system that permits a higher ground-fault current to flow to obtain sufficient current for selective relay operation. It usually meets the criteria of $R0/X0$ less than or equal to 2. Ground-fault current is typically between 100 A and 1000 A.

C. Transformer Configuration

The primary and secondary winding can be connected in either wye (Y), delta (Δ) or wye-grounded (Yg) configurations. These result in nine possible combination of connections are Y-Y, Y-Yg, Y-Δ, Yg-Y, Yg-Y, Yg-Δ, Δ-Y, Δ-Yg and Δ-Δ. The zero-sequence impedance seen looking into a transformer depends upon the configuration of the winding. The zero-sequence impedance of a Δ winding is infinite, whereas the zero-sequence impedance of a Y-connected winding is a series composite of the zero-sequence impedance of the transformer and the impedance of any neutral grounding devices that might be present. Thus, an ungrounded Y-winding would present an infinite zero-sequence impedance because the absence of a neutral grounding connection appears as an open circuit in series with the zero-sequence impedance of the transformer winding [11].

The equivalent circuit for the zero-sequence impedances depends on the winding connections and also upon whether or not the neutral is grounded. Figure 1 shows the connection

diagram of some transformer configuration and their zero-sequence equivalent circuits [11].

In Yg-Yg connections, because both neutrals are grounded, there exist a path for zero sequences current to flow in the primary and secondary. In Yg-Y connections, the sum up secondary phase current is zero because the secondary neutral is isolated. For Yg-Δ connections, the primary currents can flow because there is zero-sequence circulating current in the Δ-connected secondary and ground return path for Y-connected primary. In Y-Δ, zero sequences current cannot flow and the equivalent circuits reflect an infinite impedance because the neutral is isolated.

Zero-sequence components of current can flow through a Yg-Yg connected transformer if a neutral path exists on both sides of the transformer. An example is shown in Figure 2. Where a Δ-Yg connected transformer, T1, supplies power to a Yg-Yg connected transformer, T2. A fault on the load side of T2 produces a zero-sequence current, which flows in the primary and secondary windings of that transformer. Zero-sequence current is permitted to flow in the primary of T2 because a path exists in the Δ-Yg connected transformer T1. Disconnecting any of transformer neutrals, on either T1 or T2, would prevent the flow of zero-sequence current in both transformers, except as allowed by magnetizing reactance. Depending upon the connections to the transformer, the use of a Yg-Yg transformer can result in a single system, or its load side may be a separately derived system.

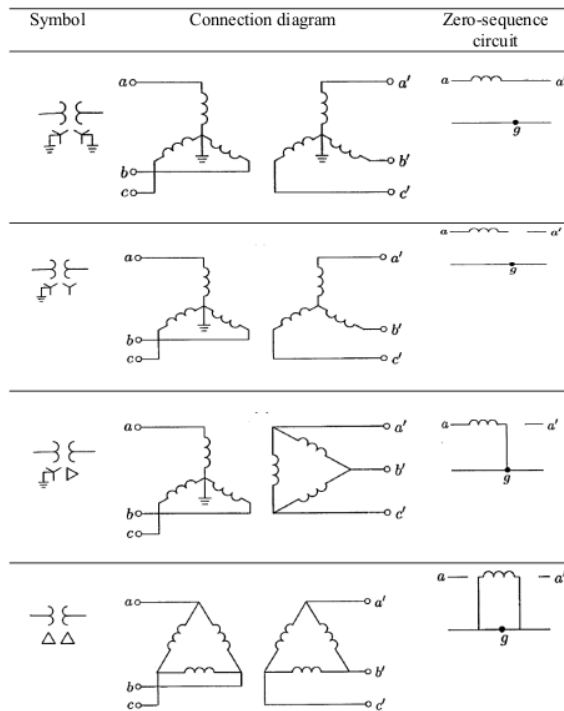

Figure 1. Connection diagram and zero-sequence equivalent circuits [5], [11]

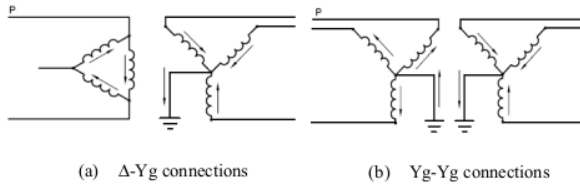

Figure 2. Connection diagram of Δ-Yg and Yg-Yg transformer

III. RESEARCH METHOD

To analyze the performance of various neutral grounding resistor and transformer connections during single line-to-ground fault (SLG), a single-line diagram for the model simulation as illustrated in Figure 3. The following are the system parameters for the testing of the model :

G1=G2=100 MVA; 20 kV; f= 60 Hz; X/R ratio =10
 T1=T2 = 100 MVA; 20/220 kV
 L12 =L13=L23= 220 kV; line length = 100 km
 Extensive simulation tests are carried out. The adjusted parameters are as follows :

- Case 1 : Change the type of transformer connection for fix resistance grounding. The kinds of transformer connection are Y-Y, Y-Yg, Y-Δ, Yg-Y, Yg-Y, Yg-Δ, Δ-Yg and Δ-Δ transformer. As simulation, The SLG at line 1-2, line 2-3 and line 1-3 and bus 3.
- Case 2 : Change the various of neutral grounding resistor (NGR) element. The values of NGR are 5, 10 ohm , 100 ohm & 500 ohm
- Assume a value of fault resistance when calculating the current for a single line-to-ground fault is 10 ohm. Common values of fault resistance used are 1 to 2, 10, 20, 30, and 40 Ω [13].
- Transition time of ground fault is 1/60 until 6/60 seconds

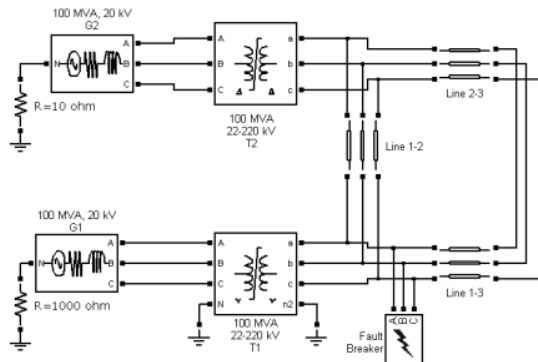

Figure 3. One line diagram for simulation

IV. ANALYSIS OF SIMULATION RESULT

A. Case 1 (various of transformer connections)

The magnitude of ground fault current (GFC) flow through NGR during SLG fault at line 1-3 for various transformer connections shown in Figure 4. The higher of SLG fault can occur at Yg-Yg transformer connection, follow by Yg-Y and Yg-Δ. In Y-Y, Y-Yg, Y-Δ, Δ-Y, Δ-Yg and Δ-Δ transformer connection, there are no current flows in NGR because zero sequences current cannot flow (Y) or no currents can leave the Δ terminals.

The similar condition for SLG fault at line 1-2 and line 2-3, comparison of ground faults current flow through NGR-G1 and NGR-G2 shown in Figure 5. Magnitude GFC at NGR affected by the fault location. This is seen when a ground fault occurs near to the generator 1 (line 1-3), then the effect of ground fault current in the NGR-G1 is greater than the current flowing in the NGR-G2 (Fig.5.a) Similarly, when a ground fault occurs in line 1-2, the NGR-G2 fault current will be greater to the GFC in the NGR-G1. At the time of ground fault occurs at bus 3, then the fault current at NGR-G1 and NGR-G2 will be the same.

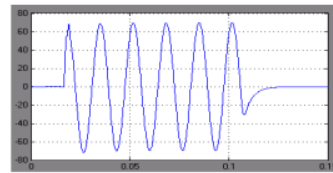

(a) GFC in NGR during SLG at Yg-Yg Transformer connection

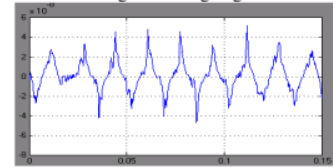

(b) GFC in NGR during SLG at Yg-Y Transformer Connection

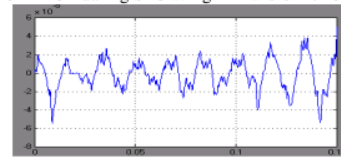

(c) GFC in NGR during SLG at Yg-Δ Transformer Connection

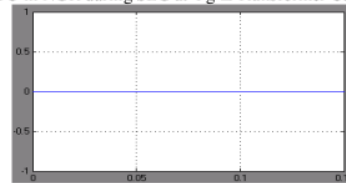

(d) GFC in NGR at Y-Y, Y-Δ, Y-Yg, Δ-Δ, Δ-Yg and Δ-Y

Figure 4. Ground fault current at various transformer connections

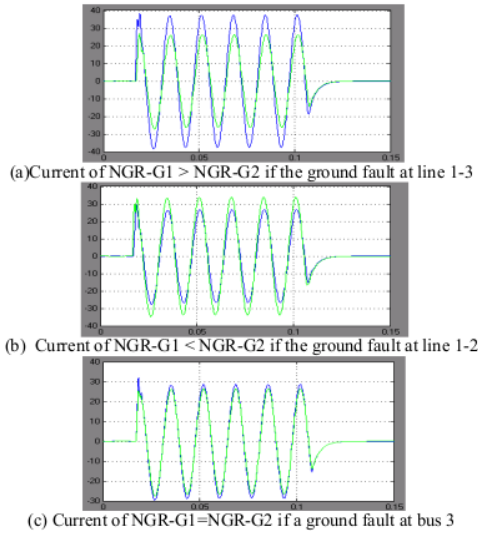

Figure 5. Ground fault current in NGR at varying ground fault locations

Thus the influence of ground fault on the transmission line to ground fault current on the generator grounding is affected by the distance of fault location of the generator and the transformer configuration. The influence of the most significant fault current of the transformer configuration occurs only in Yg-Yg, Yg-Y and Yg-Δ transformer connections.

B. Case 2 (various of NGR values)

Fig.6, shown the grounding with NGR 5 Ω, GFC flowing in the generator neutral approximately 300 A. This value is very large compared the magnitude current flowing the other conditions of NGR. The large the value of NGR, it will cause a current flowing in the NGR will be smaller.

This is a reference because the magnitude of ground fault currents depended on method of neutral grounding. If grounded via low-resistance grounded (LRG), the fault current is great enough to allow the protection tripping, but for the high-resistance grounded (HRG) as the result a very low fault current made the detection of single phase to ground fault very difficult. That ground faults in HRG do not draw enough to trigger circuit breaker or fuse operation. It became one of the considerations the use of the LRG or HRG in ground-fault protection.

Comparison of GFC with different resistance values disorders affecting the characteristic of fault current. Ground fault of the small fault resistance (10 Ω) compared to 40 Ω will result in GFC greater in the NGR element. This is due to the small value of resistance that hinders the ground fault. As same condition for varying magnitude of NGR versus transformer configuration shown at Figure 7.

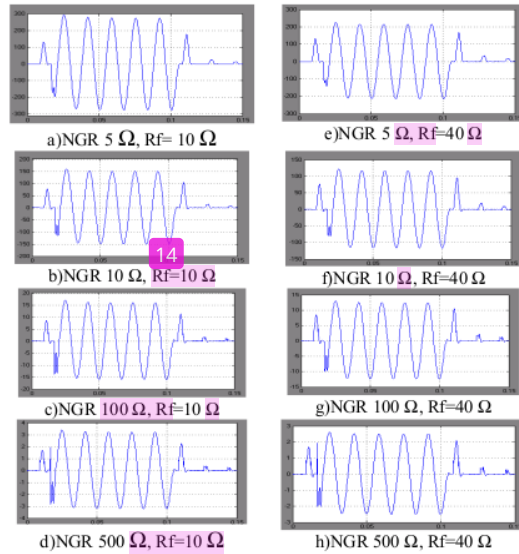

Figure 6. Ground fault current at various value of NGR and fault resistances

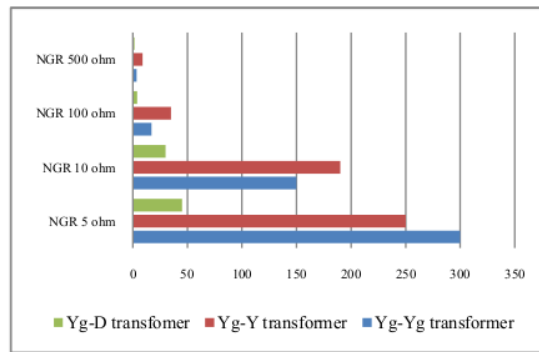

Figure 7. The effect value of NGR versus transformer configuration

V. CONCLUSIONS

Ground fault on the transmission line will affect the current flowing in the NGR element. On the unit generator-transformer, fault current in the generator neutral is greatest at Yg-Yg transformer connection followed by Yg-Y and Yg-Δ. In addition, for the transformer winding Y, Y-Yg, Y-Δ, Δ-Y, Δ-Yg and Δ-Δ no current flows through the generator neutral. The magnitude of ground fault currents be affected by the neutral grounding method. If grounded via low-resistance grounded (LRG), the fault current is great, but for the high-resistance grounded (HRG) as a result the very low fault current. According to IEEE Std 142-2007, the ground fault current for HRG limited to less than 10 A and typically between 100 A and 1000A for LRG, it is to the simulation model of NGR 500 ohm including grounding HRG and less

than of NGR 10 ohms can be categorized as LRG. To get a more accurate simulation results, simulation models and the effect of harmonic and ferroresonance can be made for further research.

ACKNOWLEDGMENT

The authors would like to thanks Universiti Teknologi Malaysia, The State Polytechnic of Ujung Pandang and Government of South Sulawesi Indonesia for providing the financial and technical support for research.

REFERENCES

- [1] IEEE Guide for AC Generator Protection, IEEE Std C37.102™-2006
- [2] IEEE Standard for Standard Terminal Markings and Connections for Distribution and Power Transformers, IEEE std. C57.12.70- 2001
- [3] IEEE Guide for Application of Transformer Connections in Three-Phase Distribution Systems, IEEE Std C57.105-1978(R2008)
- [4] IEEE Recommended Practices and Requirements for Harmonic Control in Electric Power Systems, IEEE Std 519-1992 © Institute of Electrical and Electronics Engineers, Inc. 1993.
- [5] IEEE Recommended Practice for Grounding of Industrial and Commercial Power Systems, IEEE Std 142 -2007
- [6] X Liang, W Jackson & R Laughy, Transformer Winding Connections for Industrial Applications, Copyright Material IEEE Paper No. PCIC-2007-19
- [7] Blume,Louis F, "Influence of Transformer Connections on Operation", AIEE, 1914
- [8] Hong, Ying-Yi IEEE Member Wang, Fu-Ming, "Investigation of Impacts of Different Three-phase Transformer Connections and Load Models on Unbalance in Power Systems by Optimization", IEEE Transactions on Power Systems, Vol. 12, No. 2, May 1997
- [9] Walter C. Bloomquist, Fellow IEEE," Select the right Transformer Winding Connection for Industrial Power Systems", IEEE Transactions on Industry Application, VOL. IA-11, NO. 6, November/December 1975
- [10] Fulczyk.M and Bertsch.J, "Ground-Fault Currents in Unit-Connected Generators with different Elements Grounding Neutral", IEEE Transactions on Energy Conversion, Vol. 17, March 2002
- [11] Saadat H." Power System Analysis", McGraw-Hill, 1999
- [12] Short T.A, "Electric Power Distribution Handbook", CRC Press LLC,USA, 2001
- [13] IEEE Recommended Practice for Protection and Coordination of Industrial and Commercial Power Systems, IEEE Std 242-2001, ch.8.

Ground Fault Currents in Unit Generator-Transformer at Various NGR and Transformer Configurations

ORIGINALITY REPORT

17%

SIMILARITY INDEX

PRIMARY SOURCES

- 1 Yan Gao, Xiangning Lin, Pei Liu, Zhiqian Bo. "A Generalized Morphological Transform Based Faulty Feeder Selector Suitable for the Non-Effectively Grounded Power Systems", 2007 IEEE Power Engineering Society General Meeting, 2007
35 words — 1%
Crossref
 - 2 www.wbdg.org
Internet
34 words — 1%
 - 3 Short, . "Short-Circuit Protection", Electric Power Distribution Handbook Second Edition, 2014.
30 words — 1%
Crossref
 - 4 www.ieca-inc.com
Internet
30 words — 1%
 - 5 Walter C. Bloomquist. "<![CDATA[Select the Right Transformer Winding Connection for Industrial Power Systems]]>", IEEE Transactions on Industry Applications, 11/1975
29 words — 1%
Crossref
 - 6 K.B. Niclas. "On Design and Performance of Lossy Match GaAs MESFET Amplifiers", IEEE Transactions on Microwave Theory and Techniques, 11/1982
24 words — 1%
Crossref
-

- 7 Blume, Louis F.. "Influence of Transformer Connections on Operation", Transactions of the American Institute of Electrical Engineers, 1914.
Crossref 23 words — 1%
-
- 8 J. C. Das, J. R. Linders. "Power System Relaying", Wiley, 1999
Crossref 20 words — 1%
-
- 9 Namhun Cho, Sangwon Yun, Jaesung Jung. "Determining the reverse fault current by the type of transformer and Distributed Generation in distribution system during the single-line to ground fault", Renewable and Sustainable Energy Reviews, 2019
Crossref 20 words — 1%
-
- 10 www.yumpu.com
Internet 17 words — 1%
-
- 11 www.coursehero.com
Internet 16 words — 1%
-
- 12 D. Paul, P.R. Chavdarian. "System Capacitance and its Effects on Cold Ironing Power System Grounding", 2006 IEEE Industrial and Commercial Power Systems Technical Conference - Conference Record, 2006
Crossref 15 words — 1%
-
- 13 Jimenez Toribio, Edy Ernesto. "Impact of Distributed Generation on unbalanced power systems", Proquest, 20111108
ProQuest 15 words — 1%
-
- 14 Wen-qiang Cai, Mou-fa Guo, Ze-yin Zheng, Hui Wang. "Flexible Arc Suppression Method Based on SOGI-FLL-PCI Controller and Fault Status Identification for

Distribution Networks", 2021 11th International Conference on Power and Energy Systems (ICPES), 2021

Crossref

-
- 15 pbadupws.nrc.gov 15 words — 1%
Internet
-
- 16 P. Pillai, B.G. Bailey, J. Bowen, G. Dalke et al. "Grounding and Ground Fault Protection of Multiple Generator Installations on Medium-Voltage Industrial and Commercial Systems—Part 2: Grounding Methods Working Group Report", IEEE Transactions on Industry Applications, 2004 12 words — < 1%
Crossref
-
- 17 journals.plos.org 11 words — < 1%
Internet
-
- 18 cache.industry.siemens.com 10 words — < 1%
Internet
-
- 19 Hong Ying-Yi, Wang Fu-Ming. "Investigation of impacts of different three-phase transformer connections and load models on unbalance in power systems by optimization", IEEE Transactions on Power Systems, 1997 9 words — < 1%
Crossref
-
- 20 Shull, Stephen, and Dan Perco. "Transformer Connections", Electric Power Transformer Engineering Third Edition, 2012. 9 words — < 1%
Crossref
-
- 21 Das, . "Unsymmetrical Fault Calculations", Power Engineering (Willis), 2011. 8 words — < 1%
Crossref
-
- 22 Dev Paul. "Phasor diagram of a single-phase-ground fault current in a high-resistance grounded 8 words — < 1%

power system", 2017 IEEE/IAS 53rd Industrial and Commercial Power Systems Technical Conference (I&CPS), 2017

Crossref

23 Jialong Wang, Raluca Lascu. "Zero sequence circuit of three-legged core type transformers", 2009 8 words — < 1%
62nd Annual Conference for Protective Relay Engineers, 2009

Crossref

24 T. Baldwin, F. Renovich, L.F. Saunders. "Directional ground-fault indicator for high-resistance grounded systems", IEEE Transactions on Industry Applications, 2003 8 words — < 1%

Crossref

25 canmetenergy-canmetenergie.nrcan-rncan.gc.ca 8 words — < 1%

Internet

26 ia802909.us.archive.org 8 words — < 1%

Internet

27 www.iea.lth.se 8 words — < 1%

Internet

28 A. Bermejo, C.A. Platero, F. Blazquez, F. Blaquez, E. Rebollo. "Verification of a Synchronous Machine Model for Stator Ground Fault Simulation Through Measurements in a Large Generator", 2014 2nd International Conference on Artificial Intelligence, Modelling and Simulation, 2014 7 words — < 1%

Crossref

29 Abu Hussein, Ahmed, and Mohd. Hasan Ali. "Suppression of geomagnetic induced current using controlled ground resistance of transformer", Electric Power Systems Research, 2016. 7 words — < 1%

Crossref

30 Dao Van Tu, Surachai Chaitusaney, Akihiko Yokoyama. "Maximization of distributed generation by considering system operating limits and protection reach reduction as constraints", IEEJ Transactions on Electrical and Electronic Engineering, 2012

7 words — < 1%

Crossref

31 He, . "Ground Fault Current of a Substation", Methodology and Technology for Power System Grounding He/Methodology and Technology for Power System Grounding, 2012.

7 words — < 1%

Crossref

32 D. Moody, V. Beachum, D. Shipp, W. Vilcheck, T. Natali. "Medium-voltage generator hybrid grounding system", IEEE Industry Applications Magazine, 2004

6 words — < 1%

Crossref

33 Kusic, . "Elements of Transmission Networks", Computer-Aided Power Systems Analysis Second Edition, 2008.

6 words — < 1%

Crossref

EXCLUDE QUOTES OFF

EXCLUDE SOURCES OFF

EXCLUDE BIBLIOGRAPHY ON

EXCLUDE MATCHES OFF