

PAPER • OPEN ACCESS

## The Development Mechanism of Microcontroller-Based Water Level and Temperature Control

To cite this article: S Ka'ka *et al* 2019 *IOP Conf. Ser.: Mater. Sci. Eng.* **619** 012039

View the [article online](#) for updates and enhancements.

You may also like

- [Assessment of hydrologic connectivity in an ungauged wetland with InSAR observations](#)  
Fernando Jaramillo, Ian Brown, Pascal Castellazzi *et al.*
- [Design and control system of temperature and water level in hydroponic plants](#)  
Azhari, Dervin Simanjuntak, Lukman Hakim *et al.*
- [Water level control based fuzzy logic controller: simulation and experimental works](#)  
M Khairudin, AD Hastutiningsih, THT Maryadi *et al.*



**244<sup>th</sup> Electrochemical Society Meeting**

October 8 – 12, 2023 • Gothenburg, Sweden

50 symposia in electrochemistry & solid state science

Abstract submission deadline:  
**April 7, 2023**

Read the call for papers &  
**submit your abstract!**

# The Development Mechanism of Microcontroller-Based Water Level and Temperature Control

S Ka'ka<sup>1,\*</sup>, R Tandioğa<sup>1</sup>, Lewi<sup>1</sup>, A K Muhammad<sup>1</sup>, A Rahman<sup>1</sup> and A Taufik<sup>1</sup>

<sup>1</sup> Mechatronics Study Program, Mechanical Engineering Department, Ujung Pandang State Polytechnic, 90245, Makassar, South Sulawesi, Indonesia

\* The Corresponding author E-mail address: kakasimon@ymail.com

**Abstract.** The development of Microcontroller-Based Water Level and Temperature Control is the development of Microcontroller-Based Water Level Control Design. This equipment is a tool that can be used to monitor and control the level and temperature of water. The aim of this research is to make a water level and temperature control device based on microcontroller, and to display the information of water level and temperature on the computer. The research methods used during the implementation process of this research are : literature study, hardware and software design, and data retrieval. The Microcontroller-based Water Level and Temperature Control uses two sensors, namely : ultrasonic sensor to detect water level, then the second sensor is a thermocouple sensor which is used to detect water temperature. This equipment uses a water pump to flow water from one tank to another, and the heater that used to heat water. The device has 2 buttons, where the first button is used to control the water level, and the second button is used to control the level and temperature of the water. Based on the results of the study it can be concluded that this water level and temperature control system works well as expected, where this equipment uses a multi position control system mode that has been programmed in the Arduino software and can display sensor readings in the form graphs using matlab software.

**Keywords:** Arduino Microcontroller, Ultrasonic Sensor, Thermocouple Sensor, Water Pump, Heater

## 1. Introduction

"Water Level Control (WLC)" is a tool that is used to identify water levels in a reservoir by utilizing a sensor as a detector of water level and has an actuator such as motor as a water pump. This system is widely used in the industrial world and in everyday life, because it is simple and easy maintenance. The control system is the process of controlling one or several quantities (variables, parameters) so that it is in a certain range. The combined work of various control devices in the production process is called the process control system, while all the equipment that forms the control system is called process control instrumentation [1]. According to [2], the control mode is divided into two types, namely the discontinuous control mode and the continuous control mode. The discontinuous control mode is divided into 2 types, namely two-position mode and multi-position mode. This two-position mode works only in two positions, that are on and off modes. On-off controllers are mostly used in simple control actions because their price are cheap and the control mode is the most basic. Multi-position mode is a two-position control mode that is equipped with several intermediate settings.



Microcontroller exists in a computer system that functions as a chip in the form of an IC (Integrated Circuit) that can receive input signals, process them and provide an output signal in accordance with the program loaded into it [1]. In other words, a microcontroller is a digital electronic device that has input and output as well as control with a program that can be written and deleted in a special way. The way the microcontroller works is actually reading and writing data.

The microcontroller is basically a computer on a single chip, in which there is a microprocessor, memory, Input/output (I/O) path and other complementary devices. The speed of data processing on the microcontroller is lower [3], when compared to a PC. In PC the speed of microprocessors used today has reached the order of GHz, while the speed operations of microcontroller generally range from 1 - 16 MHz Likewise, the RAM and ROM capacity on a PC can reach the order of Gbyte, compared to a microcontroller which only ranges in the order of byte/Kbyte.

One of the microcontrollers that is often used is Arduino which is an electronic circuit that is open source, and has hardware and software that is easy to use. Arduino can recognize the surrounding environment through various types of sensors and can control lights, motors, and other types of actuators. Arduino has many types, including Arduino Uno, Arduino Mega 2560, Arduino Fio, and others.

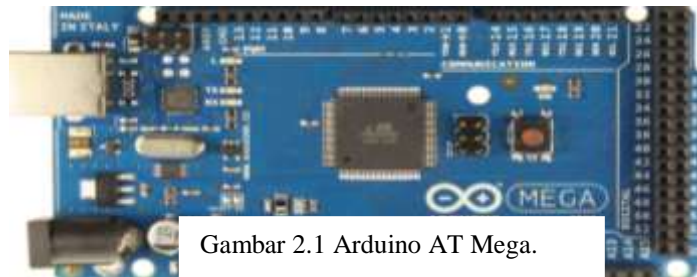

Gambar 2.1 Arduino AT Mega.

**Figure 1. An AT Mega Arduino.**

Arduino is a microcontroller board based on ATmega328. The Arduino has 14 input/output pins where 6 pins can be used as PWM outputs, 6 analog inputs, a 16 MHz crystal oscillator, USB connection, power jack, ICSP head, and reset button. Arduino is able to support the microcontroller and can be connected to a computer using a USB cable [4]. The standard statement form in the control system will be described in Figure 2.

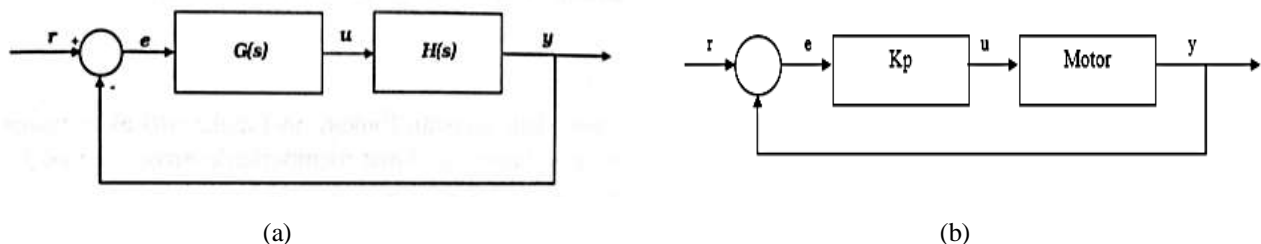

**Figure 2. Closed Loop Control and P-control**

In the figure,  $r$  is the input,  $e$  is the error,  $u$  is the controller's output signal,  $G(s)$  is the controller,  $H(s)$  is the robot dynamic, and  $y$  is the output. Now the problem is how to design  $G(s)$ .

Proportional control P applies if,  $G(s) = k$ , which is  $k$  is a constant. If,  $G(s) = k_p \cdot e$ , then the controller output equation is  $u = k_p \cdot e$ . Proportional control, P, for a motor can be illustrated as shown in Figure 2 (b). If  $K_p$  is a proportional constant, then  $K_p$  can be applied as gain without giving a dynamic effect on controller performance [5].

The use of P control has various limitations due to the non-dynamic control properties. However, in simple basic applications, this P control is quite capable of convergence even though the error in the steady state is relatively large. For example, in controlling the rotational speed of a dc motor, using proportional control, P, if the rotational speed is a function of time  $t$  (s), then the controller output  $u(t)$  is :

$$u(t) = Kp. (\theta_{ref}(t) - \theta_{act}(t)) \quad (1)$$

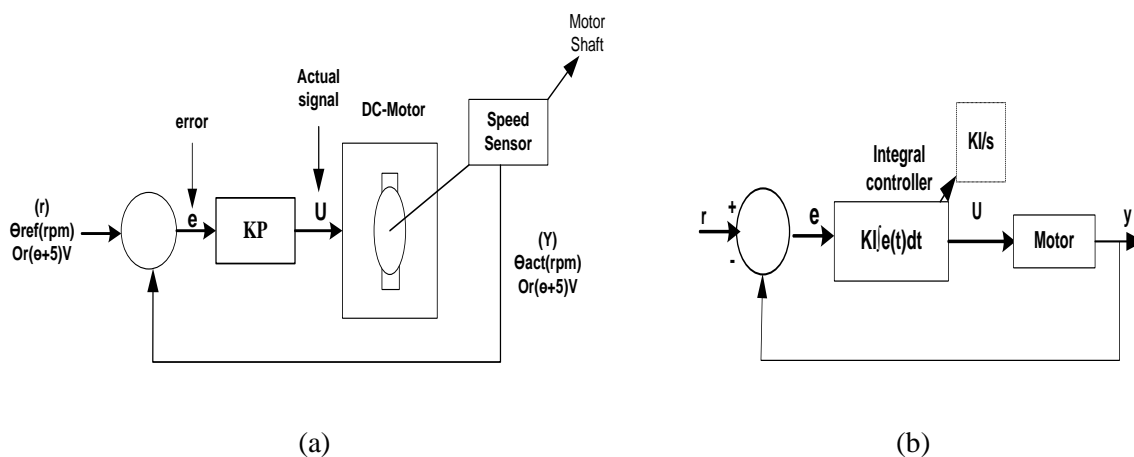
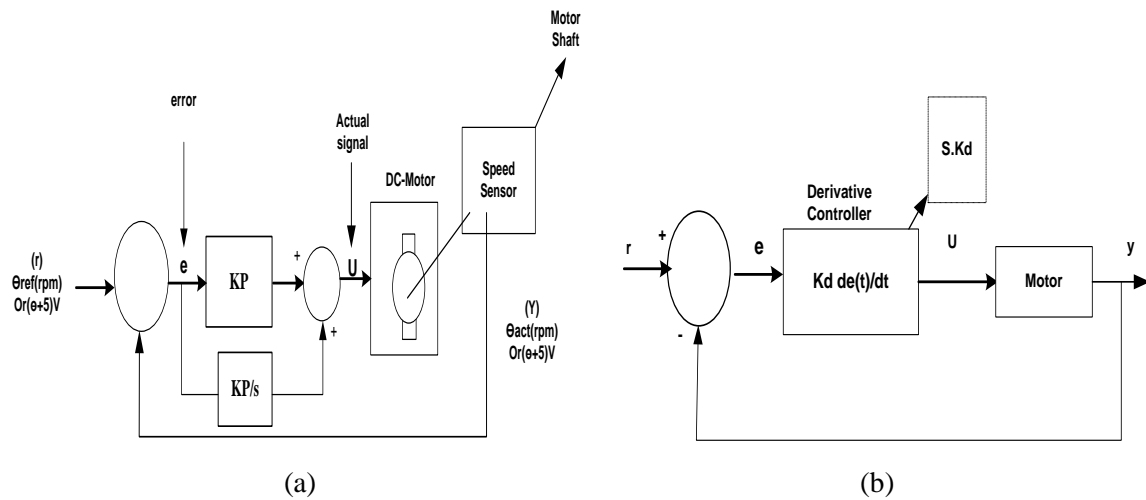

**Figure 3.** The P and I control in a DC- motor.

The controller output value depends on the representation of errors, that is the reference speed minus the actual speed, which is less than the reference speed. If error is negative, it means that the actual speed is greater than the reference speed. If the actual speed is equal to the reference speed then the output signal will be zero because the error is zero. From the point of view of circuit, this output signal will cause the motor not to get an actuation signal again. As a result the motor shaft will stop rotating. Once the shaft rotation begins to decrease, the sensor will detect that the output speed is no longer equal to the reference speed. Actual speed will be smaller than the reference speed. The meaning of error is not the same as that zero, as a result the controller will start sending a positive actuating signal,  $u(t)$ , again so that the motor will increase its speed again [6].

This is repeated so that the error at this P control cannot keep the error to always be zero, or in other words in a steady state, the error in control P cannot be zero. This is known as steady state error. The basic function of integral control, I, according to [7] is to reduce the steady state error, while control I is rarely used alone in the application. It is usually combined with P control to improve the response to achieve a minimum error. The control I parameter can be illustrated in the motor control diagram as shown in Figure 3 (b).

Combination of I control and P control for a dc motor can be described as follows :



**Figure 4** PI control and D control in DC Motor

The equation of the above controller output is :

$$u(t) = Kp. (\theta_{ref}(t) - \theta_{act}(t)) + Ki \int_0^t (\theta_{ref}(t) - \theta_{act}(t)) dt \tag{2}$$

Parameter D works in the context of the rate/speed of the error so that it can reduce the effect of overshoot (over response) towards steady state. In other words, as if the control D is able to predict errors that will occur as an effect of the error speed that is calculated before.

The D control parameter can be illustrated in the motor control diagram as follows:

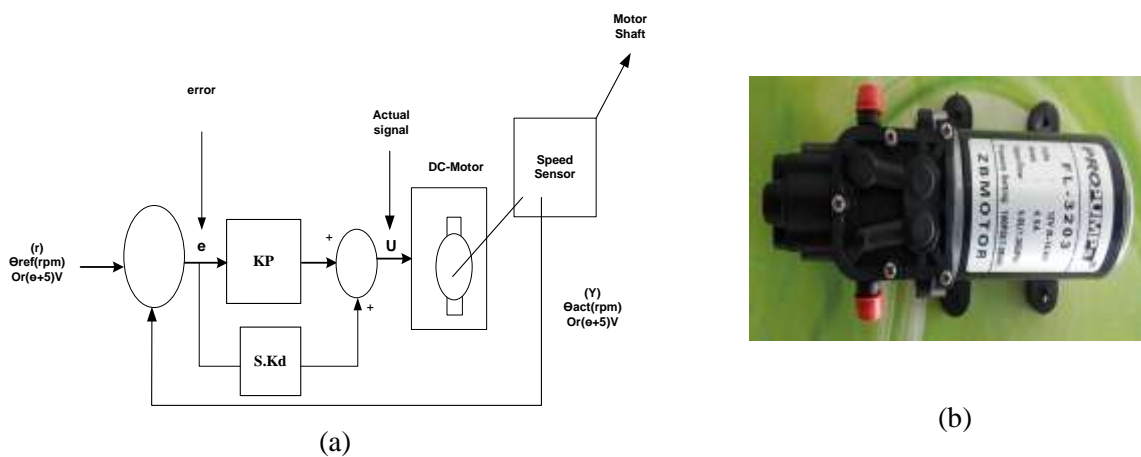

**Figure 5.** D and PD control in water pump dc motor.

Combination of D control and P control for a dc motor is described in Figure 5. So that the equation of controller output, u (t), is :

$$u(t) = Kp. (\theta_{ref}(t) - \theta_{act}(t)) + Kd. \frac{d(\theta_{ref}(t) - \theta_{act}(t))}{dt} \tag{3}$$

Pump is one of the fluid machines included in the working machine class. The pump functions to flow the fluid from a lower place to a higher place or from a lower pressure place to a higher pressure place. In addition, the pump is also used to move the fluid from a higher place to a lower place, for example in a long and winding piping system.

Sensor is an equipment used to convert a physical quantity into an electrical quantity so that it can be analyzed with a certain electrical circuit [1]. Ultrasonic sensor is a sensor that operates based on the principle of sound wave reflection and is used to detect the presence of a particular object in front of it. Its working frequency is in the area above the sound wave from 40 kHz to 400 kHz. The ultrasonic sensor according to [8] is composed of two units, that are the transmitter and the receiver unit. The structure of the transmitter and receiver unit is very simple, where a piezoelectric crystal is connected to the mechanical anchor and is only connected to the vibrating diaphragm. Alternating voltage that has a working frequency in the range of 40 kHz - 400 kHz is given to the metal plate. The atomic structure of the piezoelectric crystal will contract (bind), expand or shrink based on the voltage polarity given and this is called the piezoelectric effect.

The contractions that occur are transmitted to the vibrating diaphragm so that ultrasonic waves emit into the air (surrounding area). The reflection of the ultrasonic waves will occur if there are certain objects and it will be received again by the receiving sensor unit. Then the receiving sensor unit will cause the vibrating diaphragm to vibrate and the piezoelectric effect produces an alternte voltage back with the same frequency. More details about the working principle of the ultrasonic sensor can be seen via the principle of the ultrasonic sensor in the following picture :



**Figure 6.** The working principle of an ultrasonic sensor

The amplitude of the electrical signal generated by the receiving sensor depends on the proximity of the detected object and the quality of the transmitter and receiver sensor. The process carried out on this sensor uses a reflection method to calculate the distance between the sensor and the target object.

The distance between the sensors is calculated by multiplying the half time used by the ultrasonic signal on its way from the sending circuit until it is received by the receiving circuit with the propagation speed of the ultrasonic signal on the air medium used [9]. The ultrasonic wave reflection can be used to measure the distance between the sensor and objects that can ideally be calculated by the following formula :

$$s = 0,5 \cdot v \cdot t \quad (4)$$

Where,  $s$  is the distance between the object and the sensor (m) and  $v$  is the sound propagation speed on the medium which is 344 m/sec,  $t$  = traveling time (seconds). The reflection principle of this ultrasonic sensor can be seen in Figure 6. The Ultrasonic Receiver will receive ultrasonic signals emitted by ultrasonic transmitters with suitable frequency characteristics. The received signal will experience the frequency filtering process by using a band pass filter circuit, with the determined value of the pass-frequency.

Then the output signal will be amplified and passed to the comparator circuit with the reference voltage which is determined based on the amplifier output voltage when the distance between the mini vehicle sensor and the divider wall reaches a minimum distance to turn. It can be assumed that the comparator output in this condition is high (logic 1) while a longer distance is low (logic 0). A temperature sensor of DS18B20 type is a digital temperature sensor which has an ADC (Analog to Digital Converter) in it with 12 bit resolution. This sensor has a fairly high level of accuracy that is  $\pm 0.5\text{ }^{\circ}\text{C}$  in the temperature range of  $-10\text{ }^{\circ}\text{C}$  to  $+85\text{ }^{\circ}\text{C}$  and overall can measure temperatures from  $-55\text{ }^{\circ}\text{C}$  to  $+125\text{ }^{\circ}\text{C}$ . This ADC resolution will be related to the temperature increase of each analog level, i.e. resolution of 9 bits has the temperature rise for each analog level of  $0.5\text{ }^{\circ}\text{C}$ , resolution of 10 bits has the temperature rise for each analog level of  $0.25\text{ }^{\circ}\text{C}$ , resolution 11 bits has the temperature rise for each analog level of  $0.125\text{ }^{\circ}\text{C}$ , and the resolution 12 bit has the temperature increase of each analog level of  $0.0625\text{ }^{\circ}\text{C}$ .

## 2. Research Methods

### 2.1. Flow Chart of Water Level and Temperature Control

Flow chart form of the mechanism of water level height and its temperature control using ultrasonic and temperature sensor is shown in Figure 7.

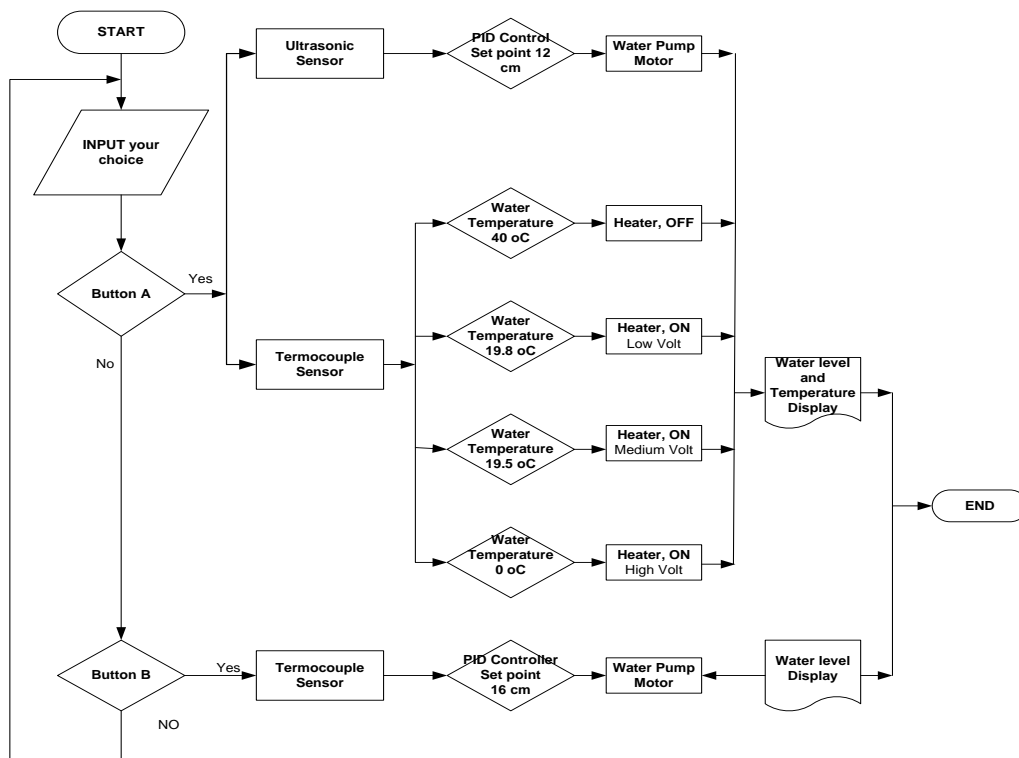

Figure 7. Flow chart of water level and temperature control.

### 2.2. Experiments

The Format of temperature registers on DS18B20 in Figure 8, is firstly calibrated to degrees Celsius,  $^{\circ}\text{C}$ . In registers sizing of 2 bytes or 16 bits there is Sign-bits (S) which functions to indicate whether the temperature is in a positive state (getting hotter) or in a negative state (getting cooler).

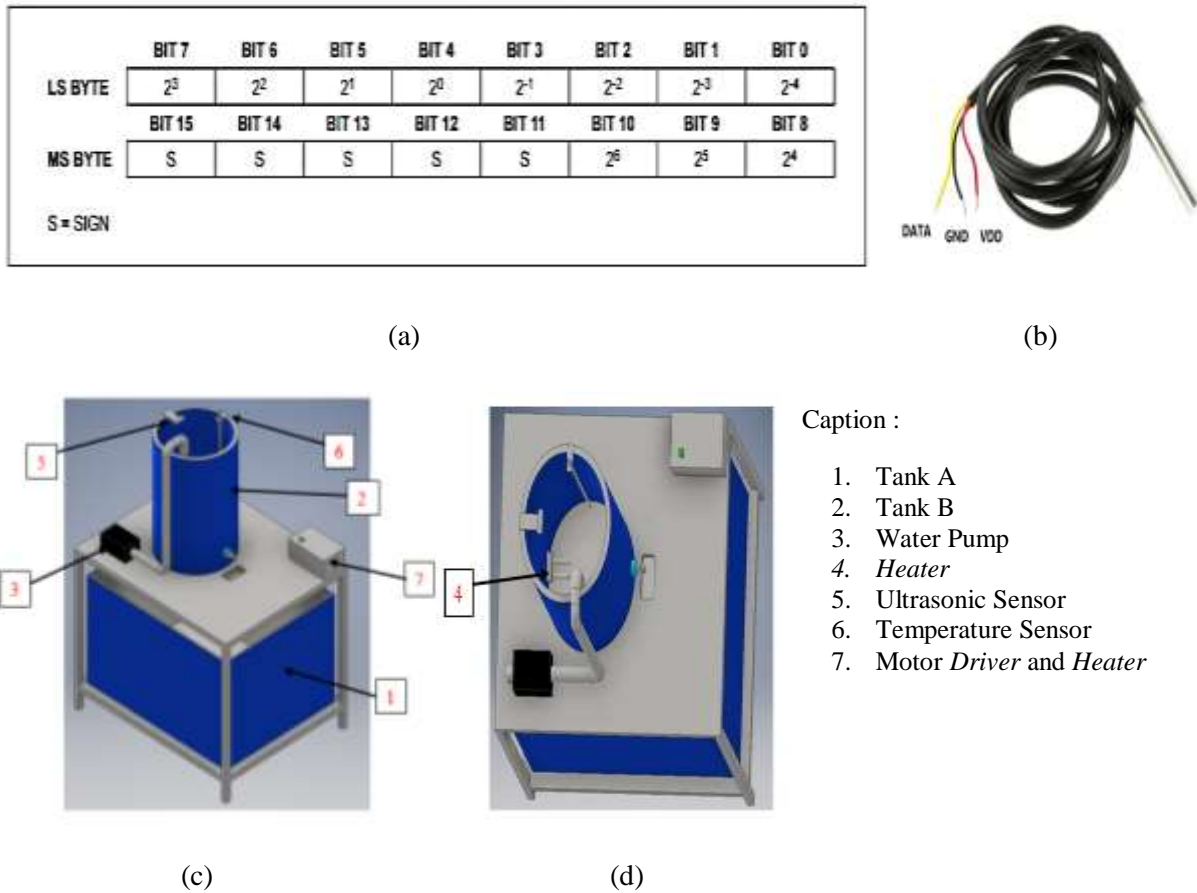

Figure 8. Format of Register, temperature sensor, DS18b20, water level and temperature control device.

Table 1. The output data of digital sensor DS18b20

TEMPERATURE (°C)	DIGITAL OUTPUT (BINARY)	DIGITAL OUTPUT (HEX)
+125	0000 0111 1101 0000	07D0h
+85*	0000 0101 0101 0000	0550h
+25.0625	0000 0001 1001 0001	0191h
+10.125	0000 0000 1010 0010	00A2h
+0.5	0000 0000 0000 1000	0008h
0	0000 0000 0000 0000	0000h
-0.5	1111 1111 1111 1000	FFF8h
-10.125	1111 1111 0101 1110	FF5Eh
-25.0625	1111 1110 0110 1111	FE6Fh
-55	1111 1100 1001 0000	FC90h

Dimensions of stainless steel pipe : 0.6 cm diameter and 3.6 cm long. Jumper cable length : 91 cm with 0.4 cm diameter. Range of temperature measuring : -55 °C to + 125 °C. Accuracy : ± 0.5 °C in the temperature range of -10 °C to + 85 °C. Input voltage : 3.0 V - 5 V. Interface : Max 1-Wire Bus Protocol. Conversion time of 12-bit ADC analog to digital temperature data : 750 ms (maximum), and can use 127 DS18b20 at once in parallel.



2.3. Collecting Data

The digital data output from the DS18B20 sensor is shown in Table 1, and to communicate with the microcontroller, the DS18B20 sensor uses a 1-wire interface sensor. This means that it only uses 1 data path (and of course the ground) to send and receive data from the microcontroller.

2.4. Data Analysis

The simulation of water level control using MatLab/Simulink as shown in Figure 9, utilizes the setpoint at a height of 25 cm, while in the PID control set point control is made with  $K_p = 95$ ,  $K_I = 11$ , and  $K_D = 3.5$ .

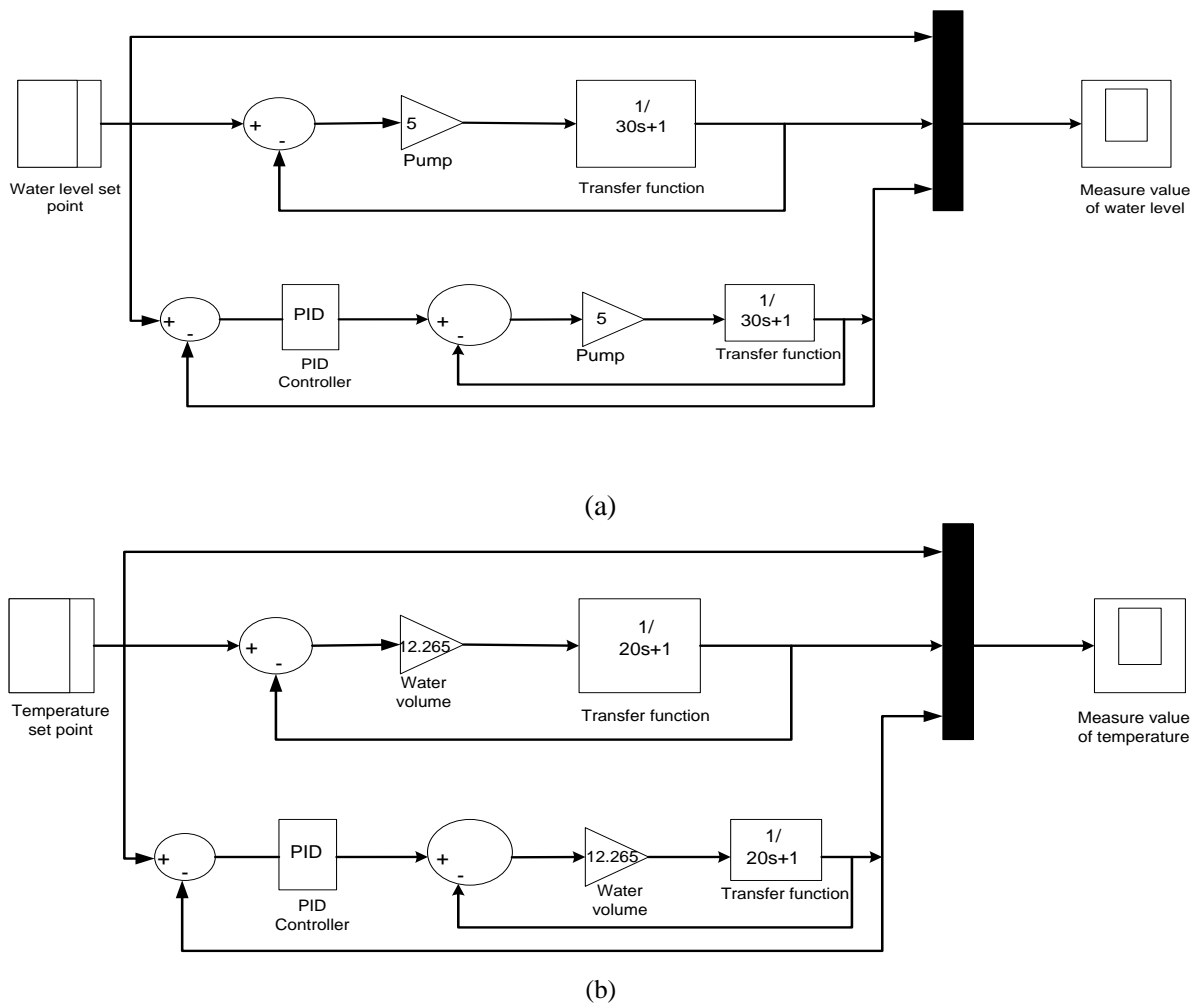
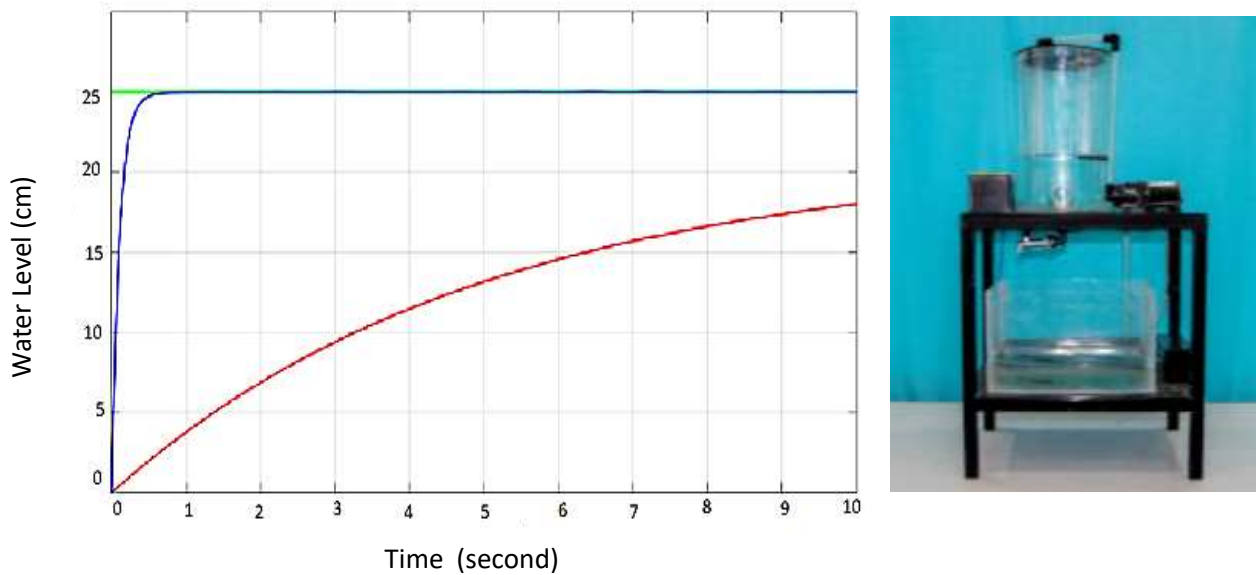

**Figure 9.** Block diagram of Mat Lab/ Simulink on water level and temperature control.

Shown in the graph that the green line is set point, blue line is a system with PID control, and red line is a system without PID control. The simulation results show that at the set point of 25 cm of water height, and the PID control is set at  $K_p = 95$ ,  $K_I = 11$ , and  $K_D = 3.5$ , graphs is obtained as shown in Figure 10, i.e. with the PID control it is obtained the constant level of 25 cm, while controlling without using PID has a changing water level and is at a water level of less than 20 cm in an interval of 10 s.

### 3. Results And Discussion

#### 3.1. Experiment of water level control



**Figure 10.** Graphs of Simulink program output for water level control.

#### 3.2. Experiment of water temperature control

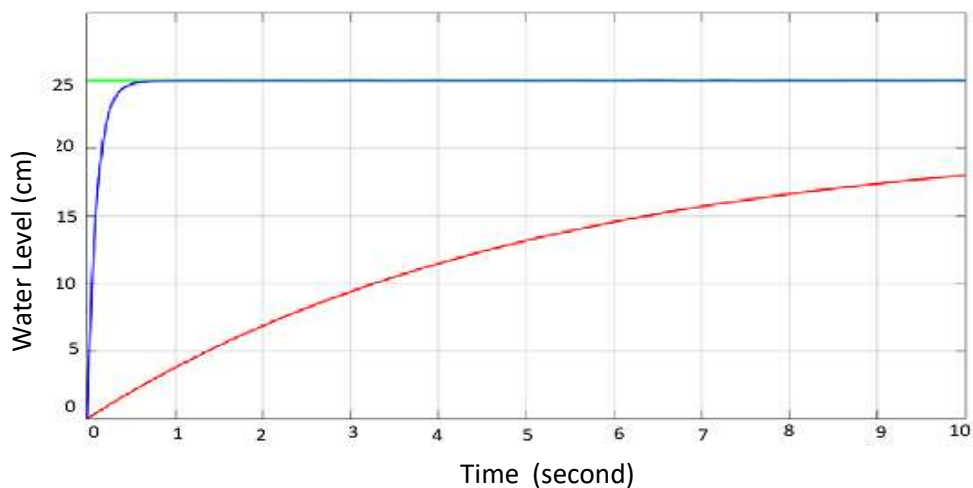

**Figure 11.** Graphs of Simulink program output for water temperature control.

In the graphs of Figure 11, if the set point is set at water temperature of 60 °C, and the PID control is set at  $K_P = 60$ ,  $K_I = 16.50$ , and  $K_D = 2$ , then the maximum water level reaches 25 cm in  $t = 0.5$  s, whereas controlling without PID results in the maximum value of the water level of 17.5 cm for 10 s.

#### 3.3. Experiment of water heater control

Based on the heating experiments using heater in related to water levels and the duration of heating, then it is obtained the water temperature as shown in Table 2 and Figure 12.

Table 2. Temperature as a result of heating with heater.

Level (cm)	Time (s)					Temperature (degree celcius)						
	I	II	III	IV	V	t0	t1	t2	t3	t4	t5	Average
12	60	120	180	240	300	25,69	25,82	26,27	27,29	28,53	30,02	0,86
10						26,02	26,49	27,25	28,18	29,26	30,45	0,88
8						26,17	26,86	27,69	28,78	29,96	31,25	1,01

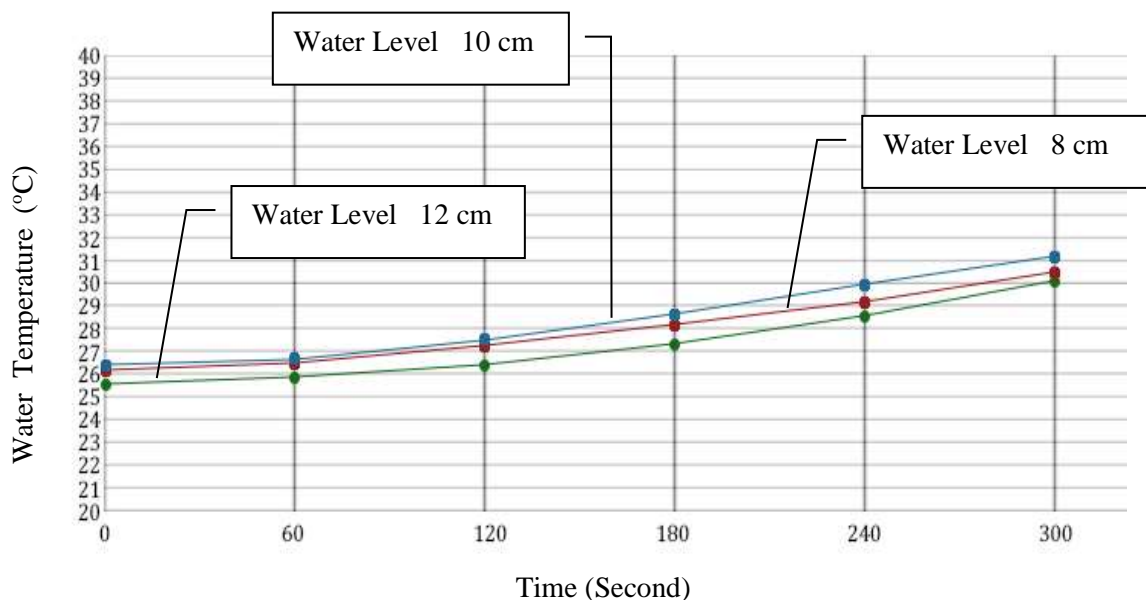

Figure 12. Graphs as a result of heating with Heater.

Based on the results of the heater test data, it is obtained that the heating power of the heater varies according to the voltage and water level in the tank. In Table 2, it can be seen that the time given in each experiment is the same i.e. 5 minutes, but the heat produced varies. When the water level is 8 cm and the voltage is 220 volt heater heats fastest, whereas at the water level 12 cm and the voltage given is 150 volts the heater heats quite long.

#### 4. CONCLUSIONS

1. This water level and temperature control system has been proven as an alternative to controlling the level and temperature of water in the storage tank. This control system uses a microcontroller and ultrasonic sensor to detect water level, and the DS18B20 temperature sensor as a water temperature detector.
2. From the tests carried out, the control circuit of water pump dc motor functions well in controlling the level and temperature of water in the reservoir tank and can be monitored on a computer screen using MATLAB software.

## REFERENCES

- [1] N. E. Budiarmo Z, "Microcontroller Based Damage Water Level Monitoring System," *Journal of Dinamika Informatika.*, *Journal of Dinamika Informatika*, 2011.
- [2] Simon Ka'ka<sup>1,2\*</sup>, Syukri Himran<sup>2</sup>, Ilyas Renreng<sup>2</sup> and Onny Sutresman<sup>2</sup>, "Pneumatic Actuator As Vertical Dynamic Load Simulator On The Suspension Mechanism Of A Quarter Vehicle Wheels," *ARPJ Journal of Engineering and Applied Sciences*, **vol. 12**, 2017.
- [3] I. d. M. A. Puluhulawa, "Design of Microcontroller Based Water Level Control Using Ultrasonic Sensors," 2016.
- [4] H. Rianto, "Car Parking Safety uses a Microcontroller Based Ultrasonic sensor," 2010.
- [5] L. Susanti, "Report on the Basic Design of Water Level Electronics Control" (Online)," 12 April 2017 2013.
- [6] S. Deny, "Water Temperature Control Module Based on PID Using MATLAB, PID-BASED WATER TEMPERATURE CONTROL USING\_MATLAB\_SIMULINK (Online), (<http://www.academia.edu/9629321/MODUL> " 2013.
- [7] M. N. K.G. Suastika, P. Yunus, "Ultrasonic Sensor As An Air Flow Meter In A Pipe," *Journal of Pendidikan Fisika Indonesia*, 2013.
- [8] S. Ka'ka<sup>1,2\*</sup>, S. Himran, <sup>2</sup> Ilyas Renreng<sup>2</sup> and Onny Sutresman<sup>2</sup>, "The Pneumatic Actuators As Vertical Dynamic Load Simulators On Medium Weighted Wheel Suspension Mechanism," *Journal of Physics*, **vol. 962**, p. 10, 2018.
- [9] Q-ELECTRONICS, "How to use DS18B20 sensor with NodeMCU," (<http://www.qelectronics.id/tutorial-sensor-ds18b20-dengan-nodemcu/>, 2016.

## ACKNOWLEDGEMENT

The authors would like to thank to the Study Program of Mechatronics Engineering, and also to the Department of Mechanical Engineering, State Polytechnic of Ujung Pandang for providing the facilities in Workshop and Laboratory.